

# K'NEX®

Building Worlds Kids Love®

COMBAT CREW  
**5-IN-1**  
BUILDING SET

ÉQUIPE DE COMBAT  
**5-EN-1**  
JEU DE CONSTRUCTION

BUILDS **5**  
CONSTRUIT LES **5**

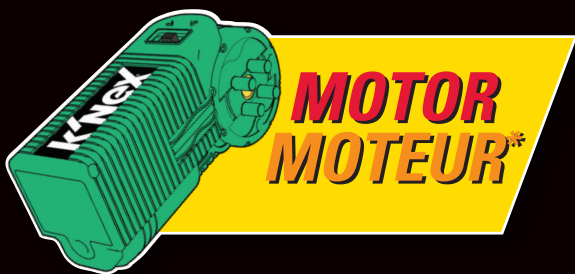

**7+**

2 x



- Not included
- Non inclus
- No se incluyen
- Nicht enthalten
- Non incluse
- Não estão incluídas
- Niet inbegrepen



\* Motore

\*\* Construye 5  
Für 5 Varianten  
Costruisci 5  
Constrói 5  
Voor 5 stuks

# CONTENTS

K'NEX Building Basics .....	4
Parts List .....	5
Helicopter .....	6
Satellite Defense Vehicle .....	20
Drone .....	28
Alternate Builds .....	37

**Keep this important information for future reference**

**⚠ WARNING:** CHOKING HAZARD - Small parts. Not for children under 3 years.

**CAUTION:** Keep hands, face, hair and clothing away from all moving parts.

- Do not aim K'NEX projectile at eyes or face.
- Never aim K'NEX projectiles at others or pets.
- Never attempt to launch any projectile other than the intended K'NEX projectile.
- Do not modify K'NEX projectile or launcher.

## Battery Information

### How to Insert and Remove Batteries

Use a small Phillips head screwdriver to loosen the screw. Insert 2 fresh AA batteries\*\*\* (LR6) into the compartment with the correct polarity (+/-) as shown here.

Install batteries before building models.

\*\*\* Not included

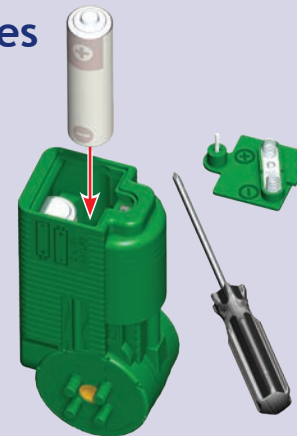

### CAUTION: To Avoid Battery Leakage

- Insert batteries with correct polarity (+/-) as shown.
- Do not mix different types of batteries.
- Do not mix alkaline, standard (carbon-zinc) or rechargeable (nickel-cadmium) batteries.
- Do not mix new and used batteries. Only batteries of the same or equivalent type recommended should be used.
- Remove exhausted batteries from the toy; do not short-circuit supply terminals.
- Remove all batteries if the toy will not be used for a long period of time.

### Important Tips

- Alkaline batteries are recommended.
- Rechargeable batteries are not recommended.
- Remove rechargeable batteries before recharging; they must be charged only under adult supervision.
- Non-rechargeable batteries must not be recharged.
- Keep components free of dust; do not immerse or use in water.
- Do not dispose of batteries in a fire; they could leak or explode and cause injury.
- Do not put rods smaller than 2 inches in any openings of the motor; they will damage the motor and cannot be removed.



The wheellie bin indicates this product cannot be disposed of with household waste due to presence of hazardous substances. To protect human health and environment, check your local authority for recycling advice and facilities (2012/19/EU, Europe only).

# CONTENUS

K'NEX Bases de Construction .....	4
Liste des Pièces .....	5
Hélicoptère.....	6
Véhicule de la Défense par Satellite.....	20
Drone .....	28
Autre Modèles .....	37

**Gardez précieusement cette notice pour vous y référer ultérieurement**

**⚠ AVERTISSEMENT : RISQUE D'ÉTOUFFEMENT** - Pièces de petite taille. Ne convient pas aux enfants de moins de 3 ans.

**ATTENTION :** Garde les cheveux, les doigts, la figure et les vêtements à l'écart de toutes les pièces mobiles.

- Ne pas viser projectile K'NEX aux yeux ou le visage.
- Ne jamais viser K'NEX projectiles vers d'autres personnes ni des animaux.
- Ne jamais tenter de lancer un projectile quelconque autre que le projectile K'NEX prévu.
- Ne pas modifier projectile K'NEX ou lanceur.

**Allez [KNEX.COM](http://KNEX.COM) à pour les mises à jour d'instruction**

## Informations sur les Piles

### Comment mettre et retirer des piles

Utiliser un petit tournevis pour desserrer la vis et pour enlever le couvercle des piles. Insérer 2 piles AA (LR6)<sup>\*\*\*</sup> neuves dans le compartiment en respectant la polarité (+/-). Installe les piles avant de réaliser tes constructions.

<sup>\*\*\*</sup> Non fournies

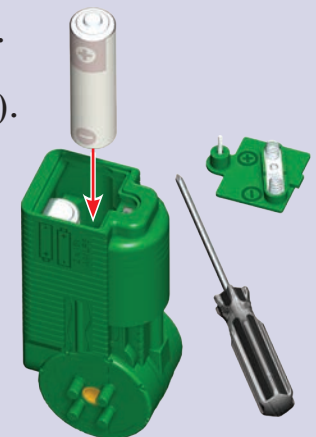

### ATTENTION : Pour éviter la fuite des piles

- Insérez les piles en respectant la polarité (+/-) comme indiqué.
- Ne pas mélanger différents types de piles.
- Ne pas mélanger des piles alcalines avec des piles standard (carbone-zinc), ou des piles rechargeables (au nickel-cadmium).
- Ne pas mélanger des piles neuves avec des piles usées. Il convient d'utiliser uniquement des piles du type recommandé ou d'un type équivalent.
- Retirer toujours les piles faibles ou mortes du produit ; ne pas faire court-circuiter les terminaux.
- Ne pas jeter les piles dans le feu ; elles risqueraient de fuir ou d'exploser et d'entraîner des blessures.

### Conseils Importants

- Les piles alcalines sont recommandées.
- Les piles rechargeables ne sont pas recommandées.
- Retirer les piles rechargeables du jouet avant de les recharger; elles doivent être chargées exclusivement en présence d'un adulte.
- Les piles qui ne sont pas rechargeables ne doivent pas être rechargées.
- Veiller à ce que les éléments restent à l'abri de la poussière ; ne pas les plonger ni les utiliser dans l'eau.
- Ne pas jeter les piles dans le feu ; elles risqueraient de fuir ou d'exploser et d'entraîner des blessures.
- N'insérez pas de tige trop courte dans le moteur, elle pourrait rester coincée et l'endommager.



Le symbole "poubelle à roulettes" indique que ce produit ne peut pas être éliminé avec vos déchets ménagers en raison de la présence de substances dangereuses.

Afin de protéger votre santé et l'environnement, renseignez-vous auprès de vos autorités locales afin d'obtenir des conseils sur le recyclage et la localisation des installations adaptées (2012/19/EU, Europe uniquement).

### Start Building

To begin your model, find the ❶ and follow the numbers. Each piece has its own shape and color. Just look at the pictures, find the pieces in your set that match and then connect them together. Try to face your model in the same direction as the instructions while you build. The arrows show you where the parts connect, but not all connections points have arrows. Faded colors show you this section is already built.

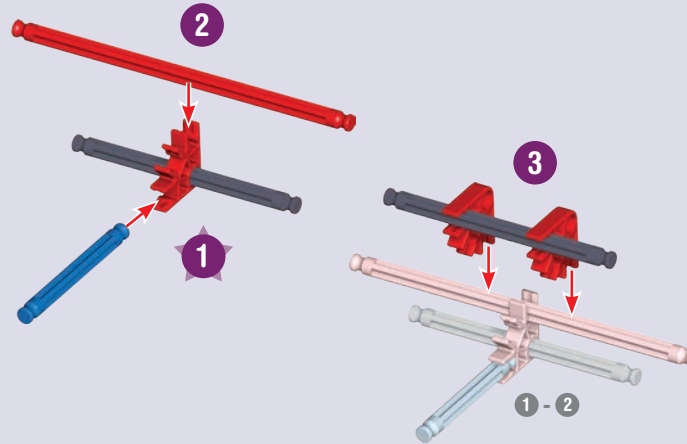

### Démarre ta Construction

Pour commencer le modèle, cherche l'étape numéro ❶ et suis les numéros dans l'ordre. Chaque pièce a sa propre forme et sa propre couleur. Regarde les illustrations, trouve les pièces qui y correspondent et les assemble-les. Pour te faciliter la tâche, oriente le modèle dans le même sens que les instructions. Les flèches indiquent où les pièces s'assemblent, mais les points de raccordement n'ont pas tous des flèches. Les pièces ayant une couleur estompée sont celles déjà assemblées.

### Connectors

You can slide these special connectors together. Push tightly until you hear a "click". Pay close attention to the instructions and position them horizontally or vertically exactly as they are shown.

### Connecteurs

Tu peux assembler ces connecteurs spéciaux en les faisant glisser l'un dans l'autre. Pousse fort jusqu'à entendre un « clic ». Lis attentivement les instructions et positionne-les horizontalement ou verticalement, en suivant exactement les illustrations.

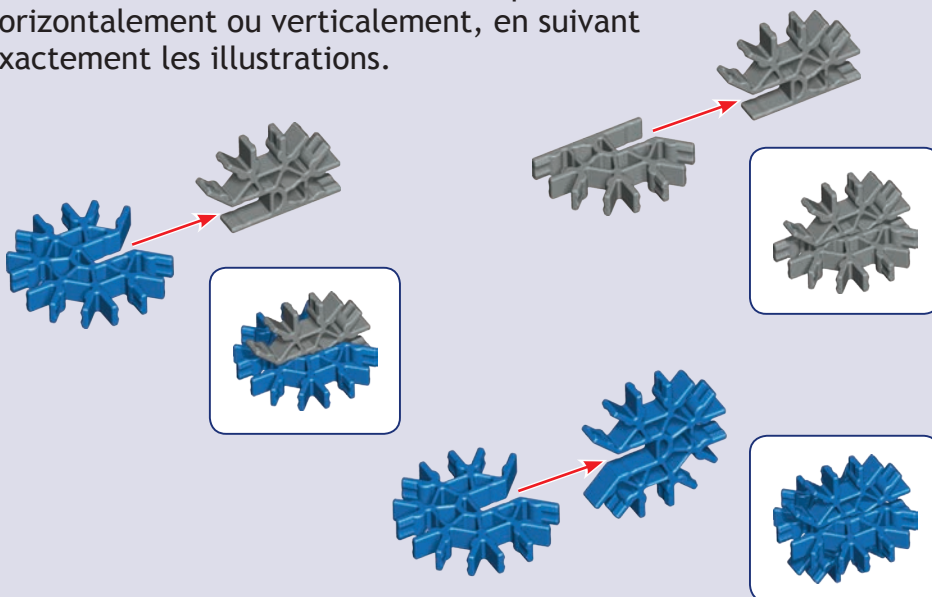

### Spacers

There are places in your model where you need to add spacers. Be sure to use the correct number of spacers shown in the instructions.

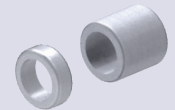

### Séparateurs

Il y a des endroits sur le modèle où des séparateurs sont nécessaires. Assure-toi d'utiliser la bonne nombre de séparateurs, comme indiqué sur les instructions.

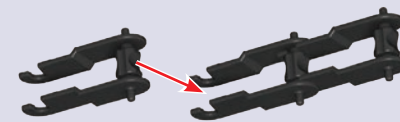

### Chain

Be sure to attach all the chain links in the same direction.

### Chaîne

Assure-toi de fixer tous les maillons de la chaîne dans le même sens.

## Parts List

Before you start building, be sure to compare the parts in your set with the parts list here. If anything is missing, call or write to us using the information on the back cover. We are here to help you!

## Liste des Pièces

Avant de commencer à construire, assure-toi de comparer les pièces dans ta boîte à la liste de pièces fournie ici. S'il manque quelque chose, téléphone-nous ou écris-nous en te servant des informations figurant au verso de la notice. Nous sommes là pour t'aider !

### AMERICAN MADE PARTS FAIT AUX ÉTATS-UNIS

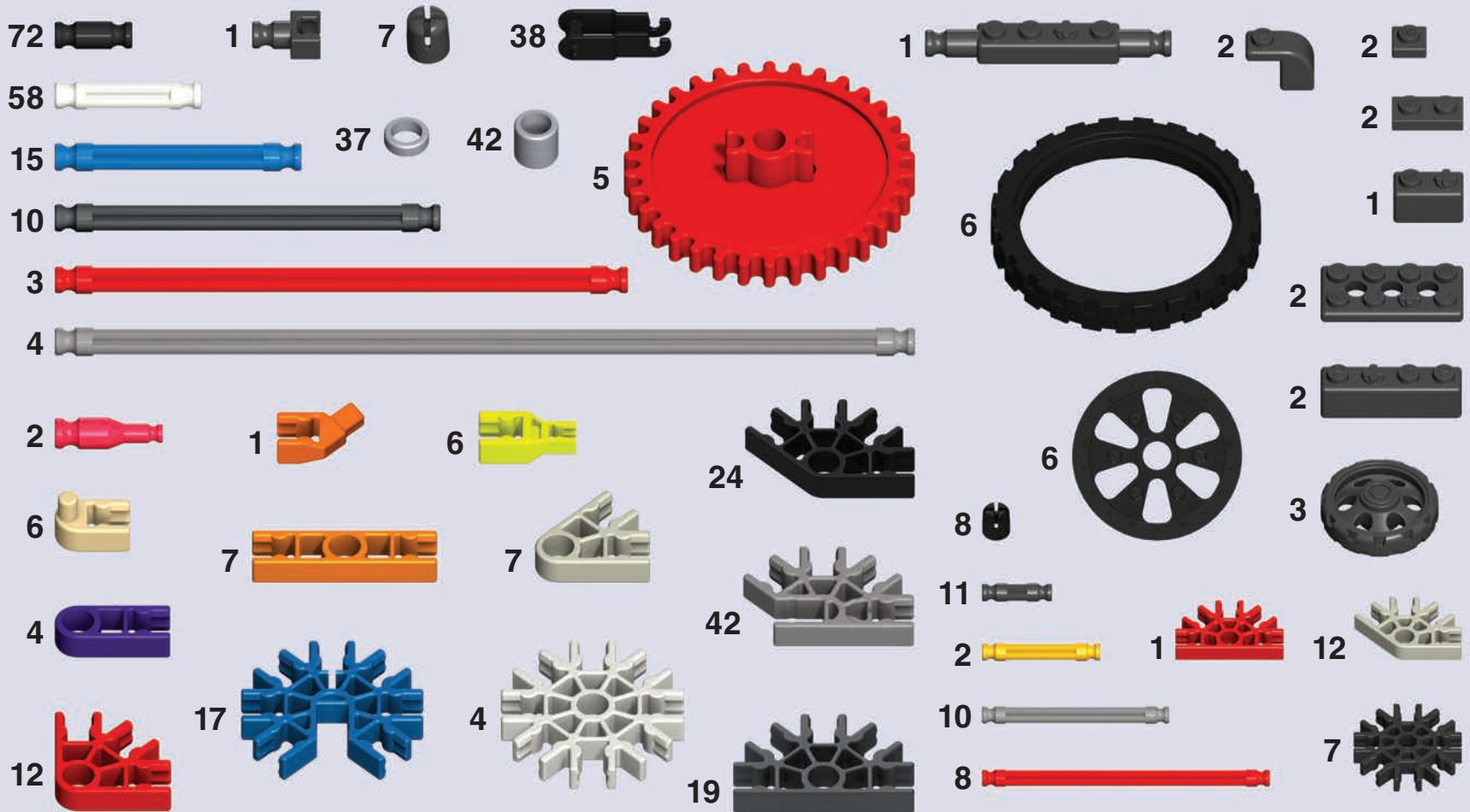

### CHINA MADE PARTS FAIT AUX CHINE





COMBAT CREW

5-IN-1

HELICOPTER

ÉQUIPE DE COMBAT

5-EN-1

HÉLICOPTÈRE

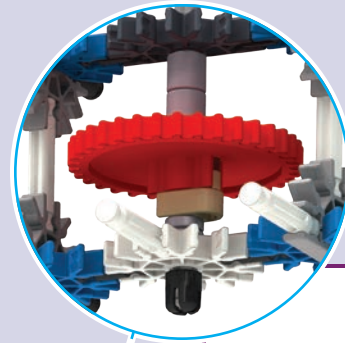
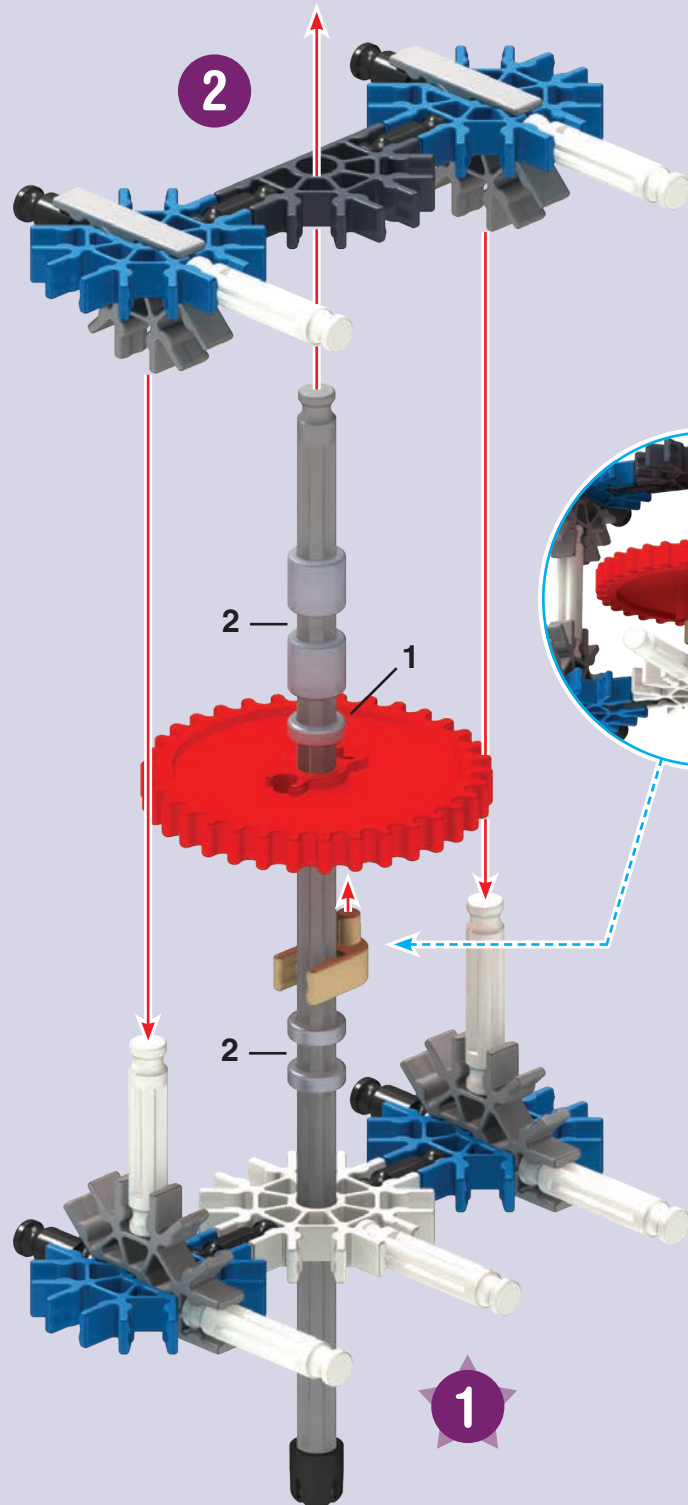
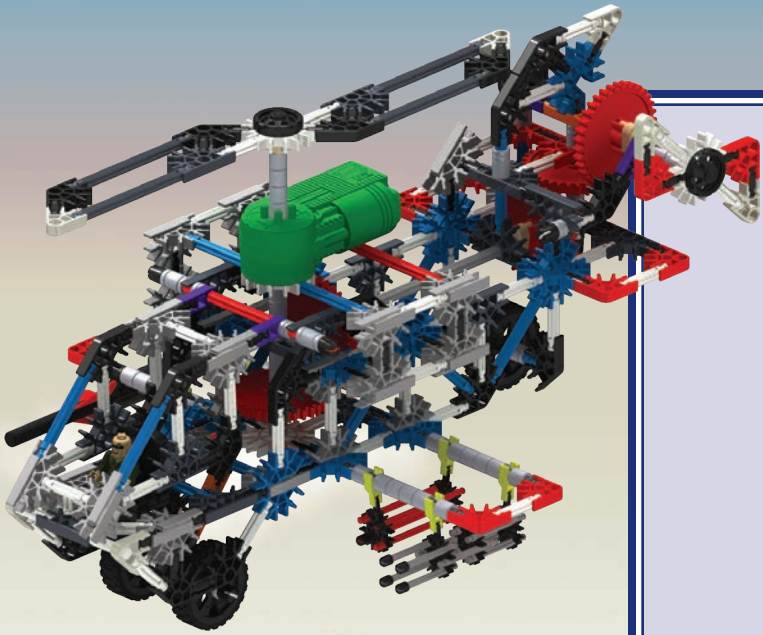

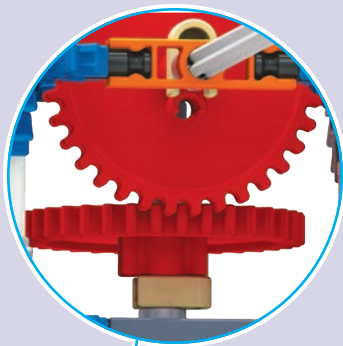

Make sure the gears mesh.  
 Surveille l'engrènement.  
 Asegúrate de que los engranajes concuerdan  
 Sicherstellen, dass die Zahnräder verzahnen.  
 Assicurarsi gli ingranaggi ingranano.  
 Assegure-se de que malha de engrenagens.  
 Zorg ervoor dat de tandwielen aangrijpen.

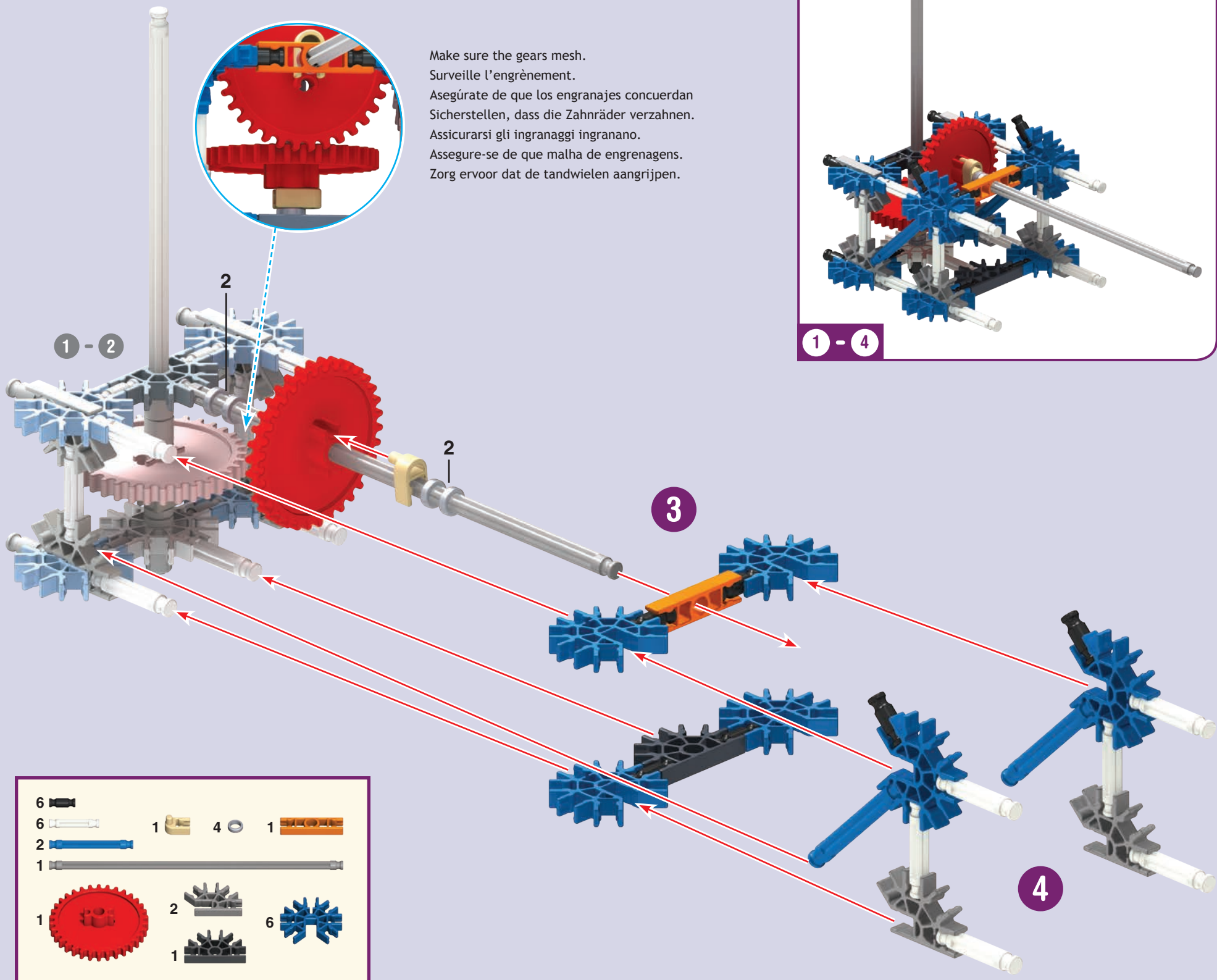

1 - 4

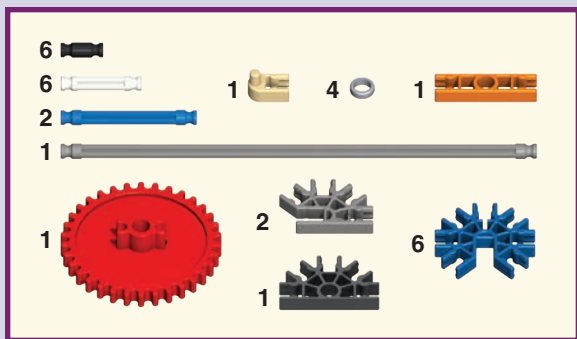

- |   |  |   |  |   |  |
|---|--|---|--|---|--|
| 2 |  | 2 |  | 2 |  |
| 6 |  | 2 |  | 2 |  |
| 5 |  | 2 |  | 2 |  |
| 4 |  | 2 |  | 2 |  |
| 2 |  |   |  |   |  |

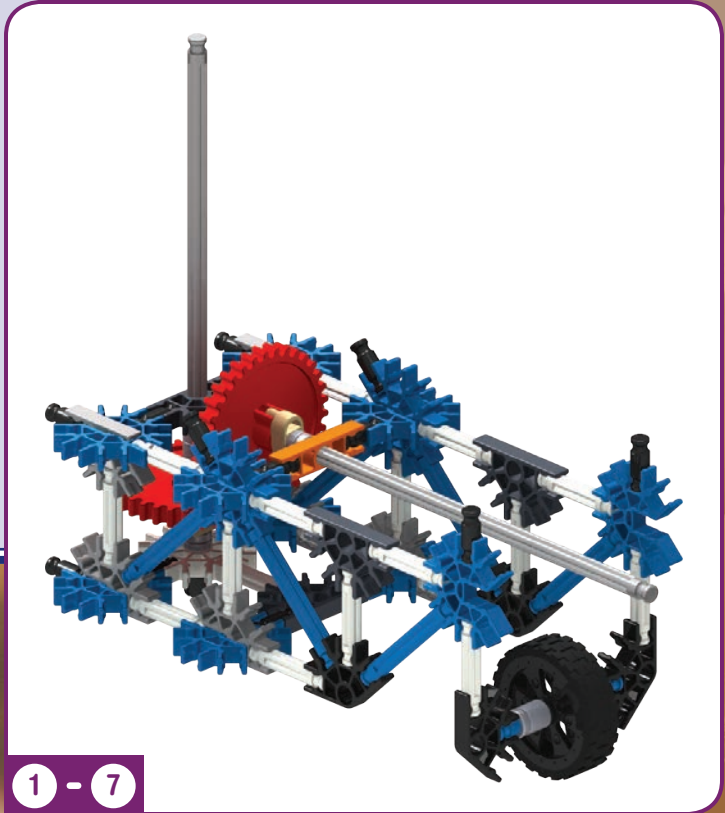
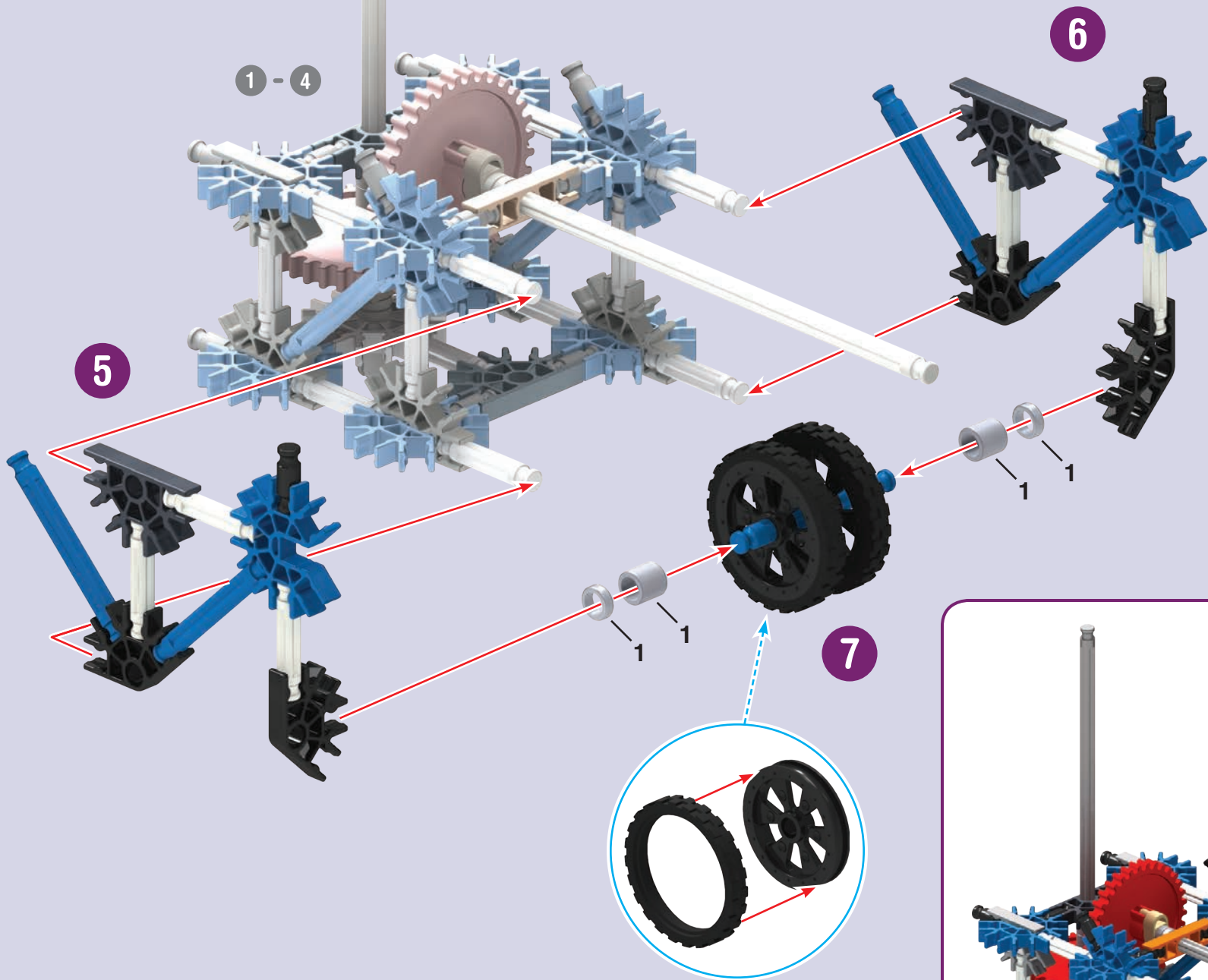



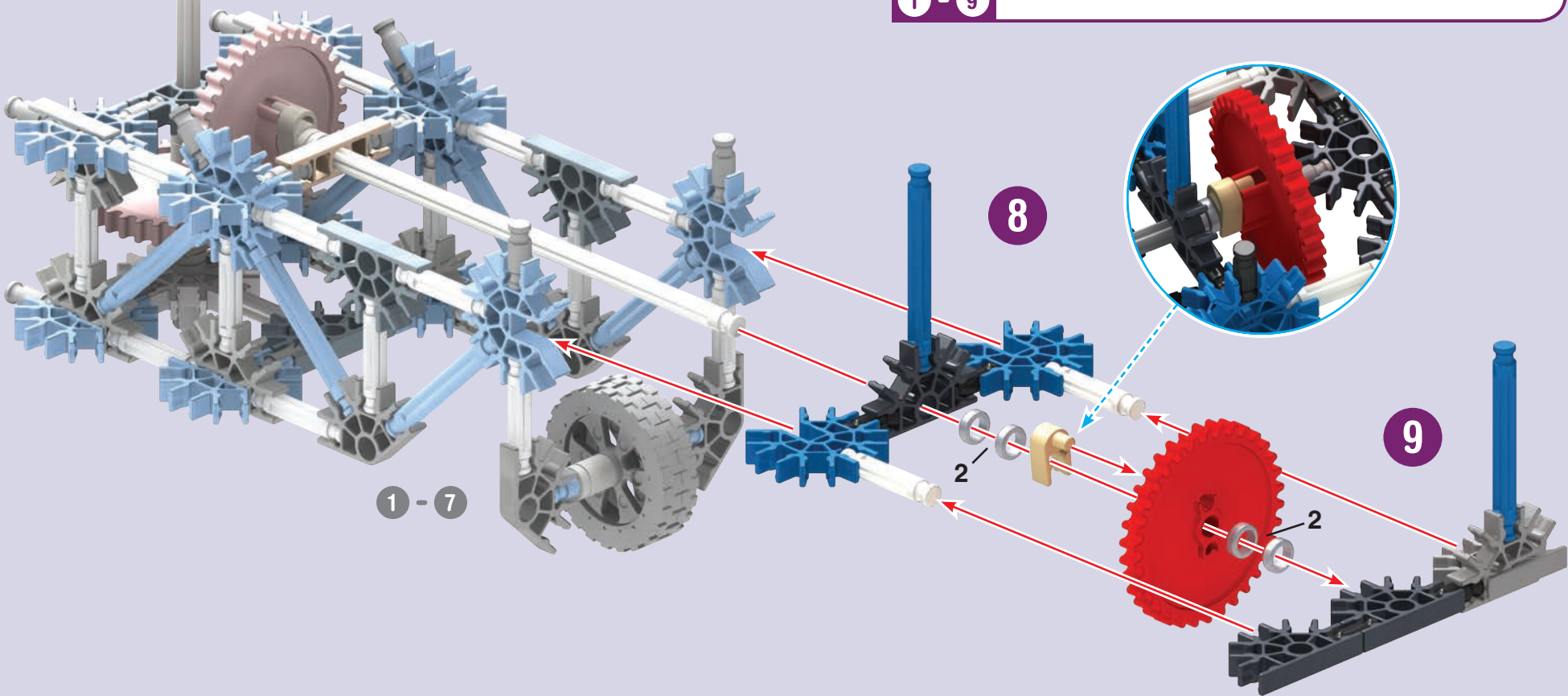
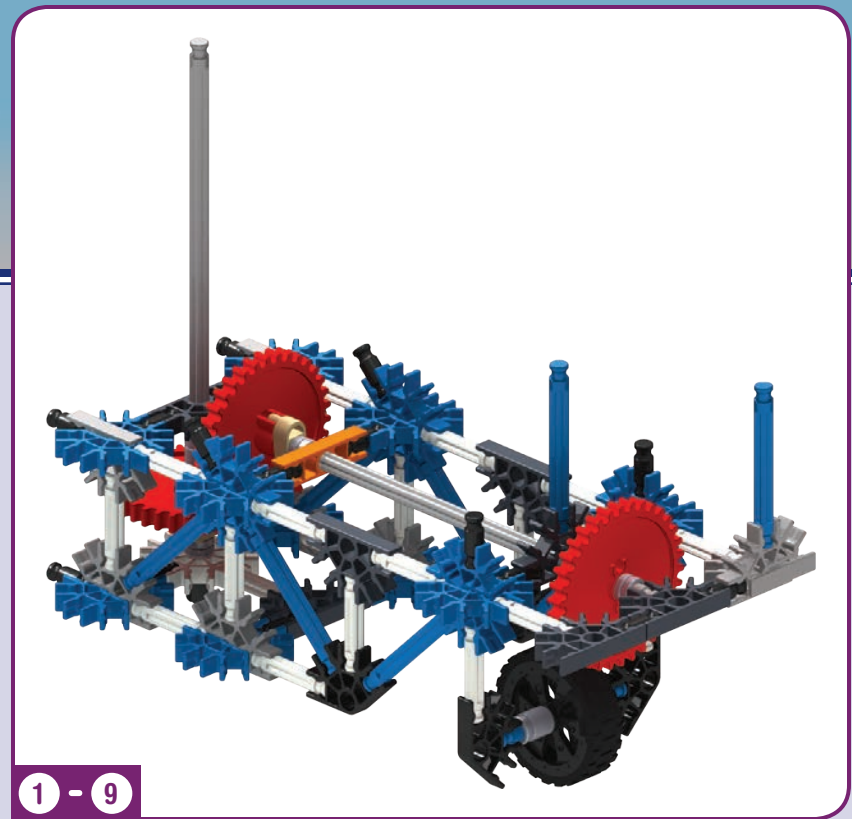
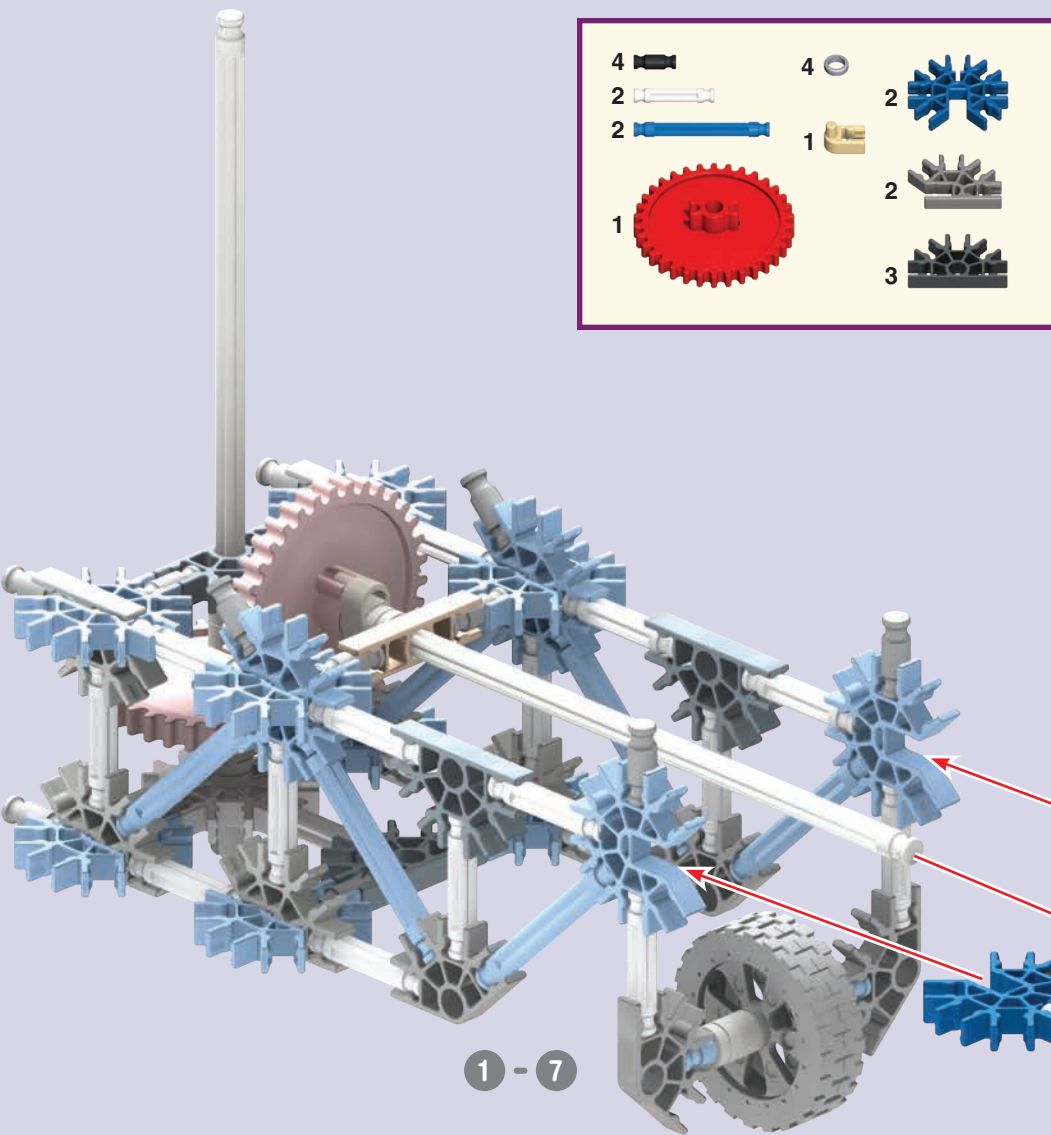

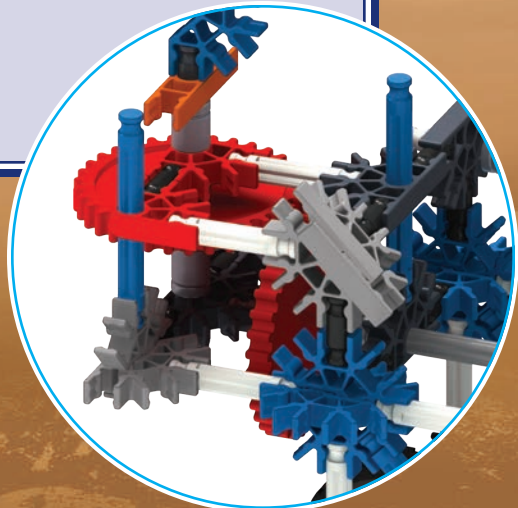
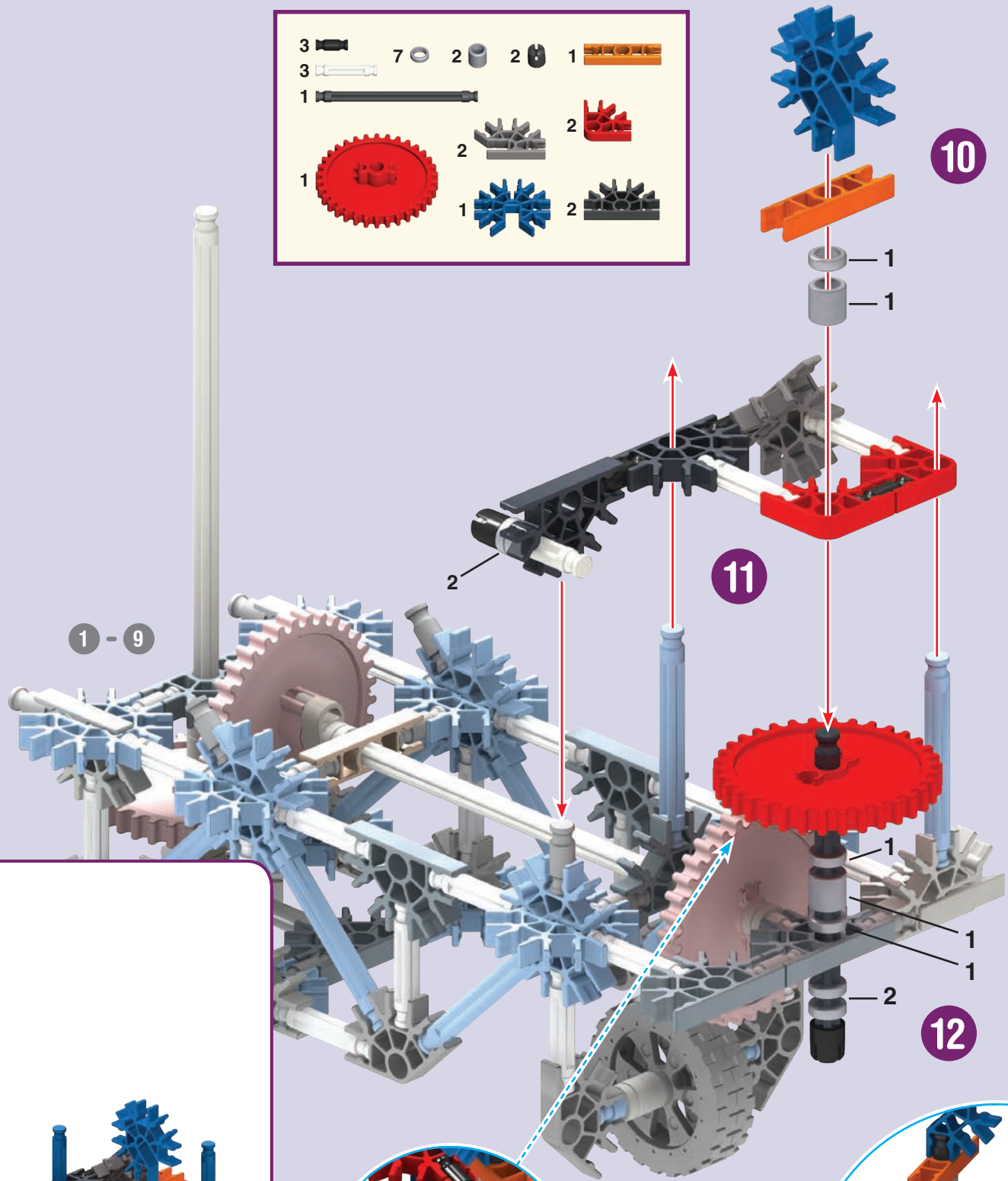
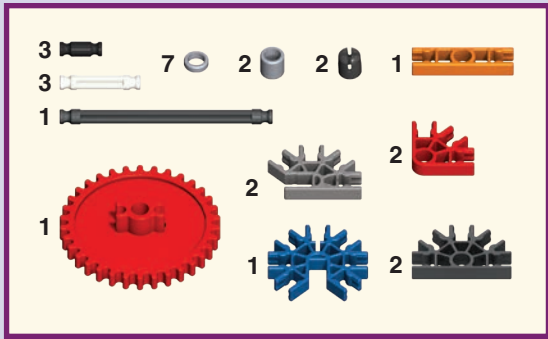

1 - 12

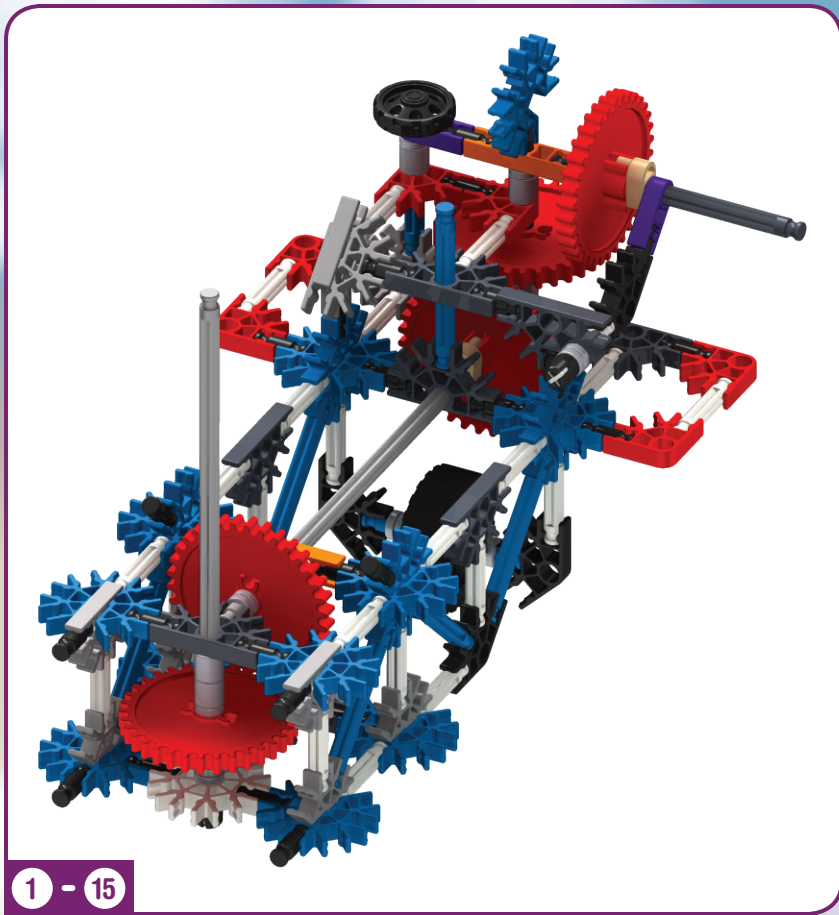

1 - 15

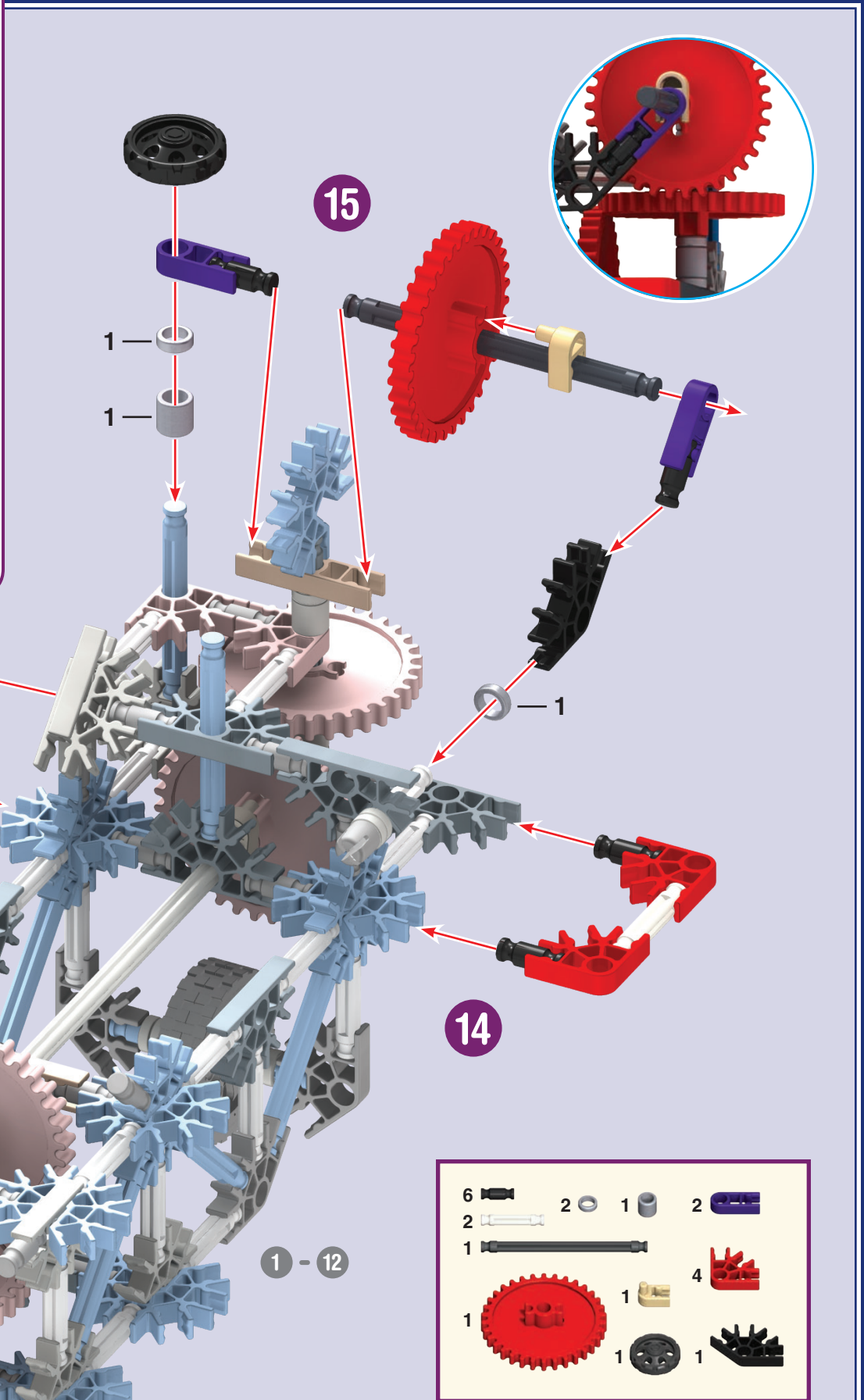

15

1

1

1

13

14

1 - 12

- |   |  |   |  |   |  |   |  |
|---|--|---|--|---|--|---|--|
| 6 |  | 2 |  | 1 |  | 2 |  |
| 2 |  |   |  |   |  |   |  |
| 1 |  |   |  |   |  | 4 |  |
| 1 |  | 1 |  |   |  |   |  |
|   |  | 1 |  | 1 |  |   |  |

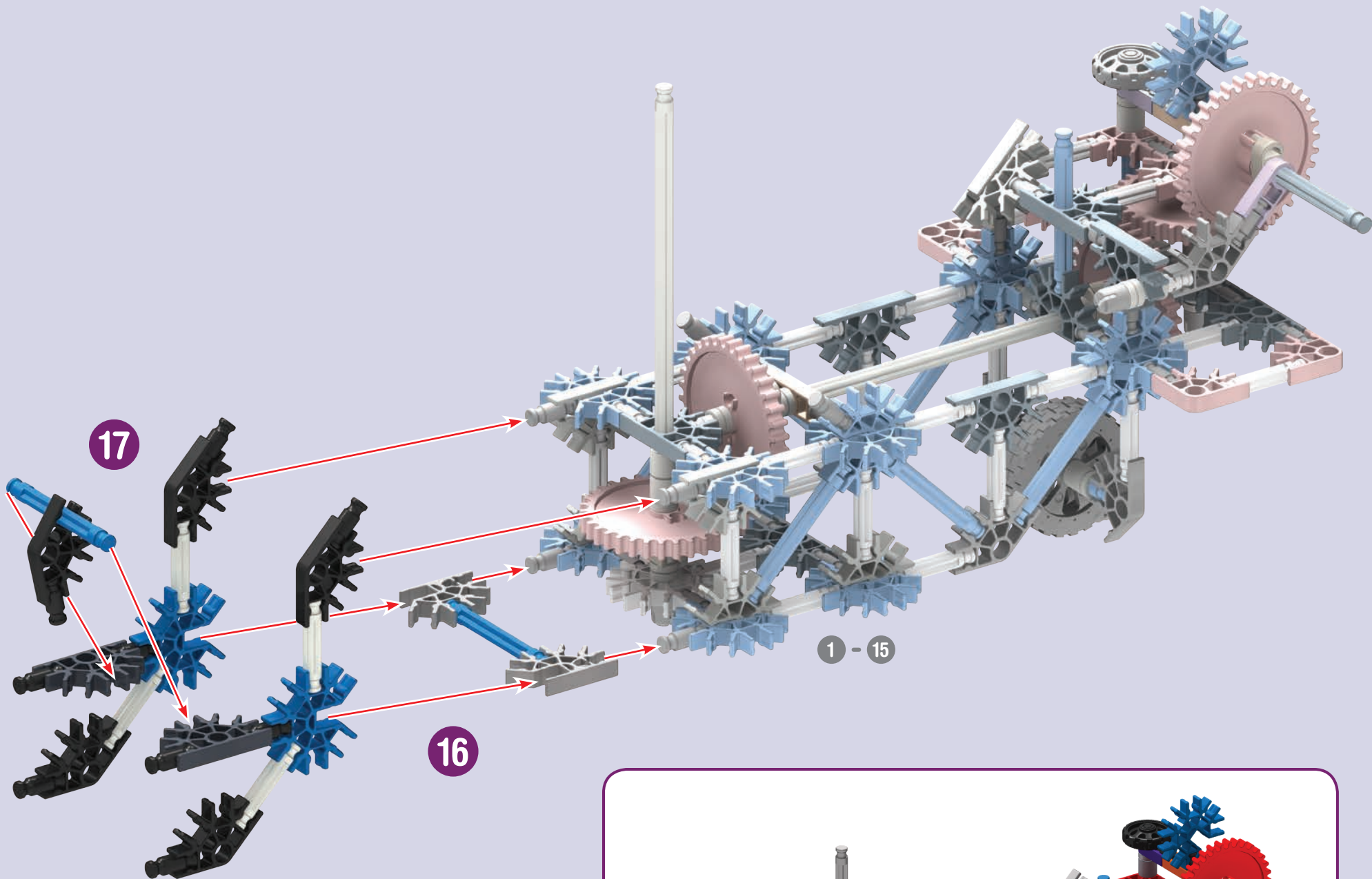

16

1 - 15

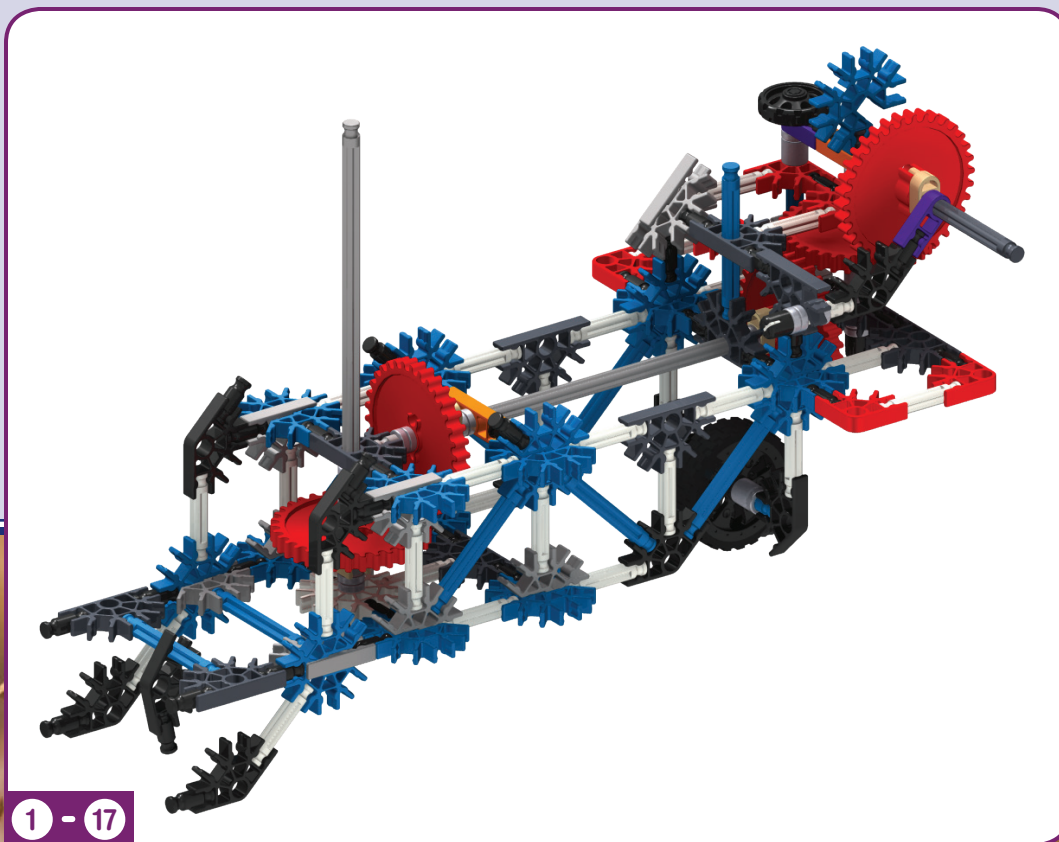
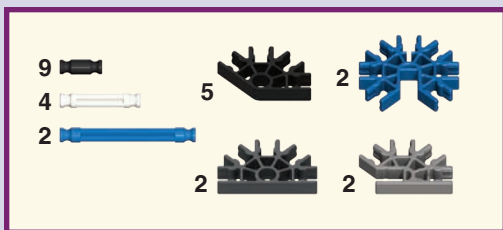

1 - 17

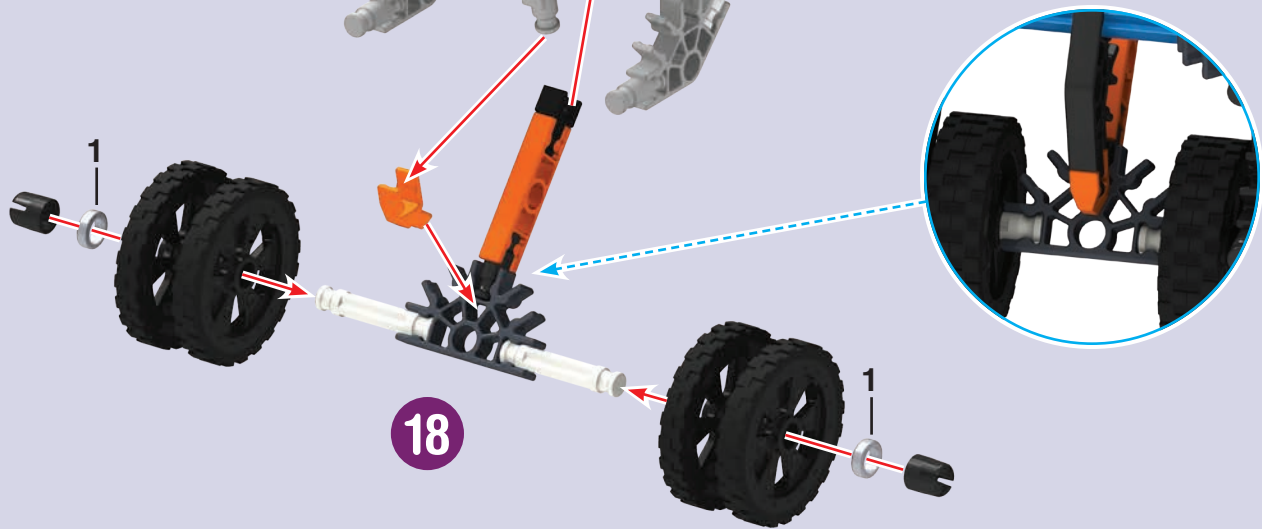
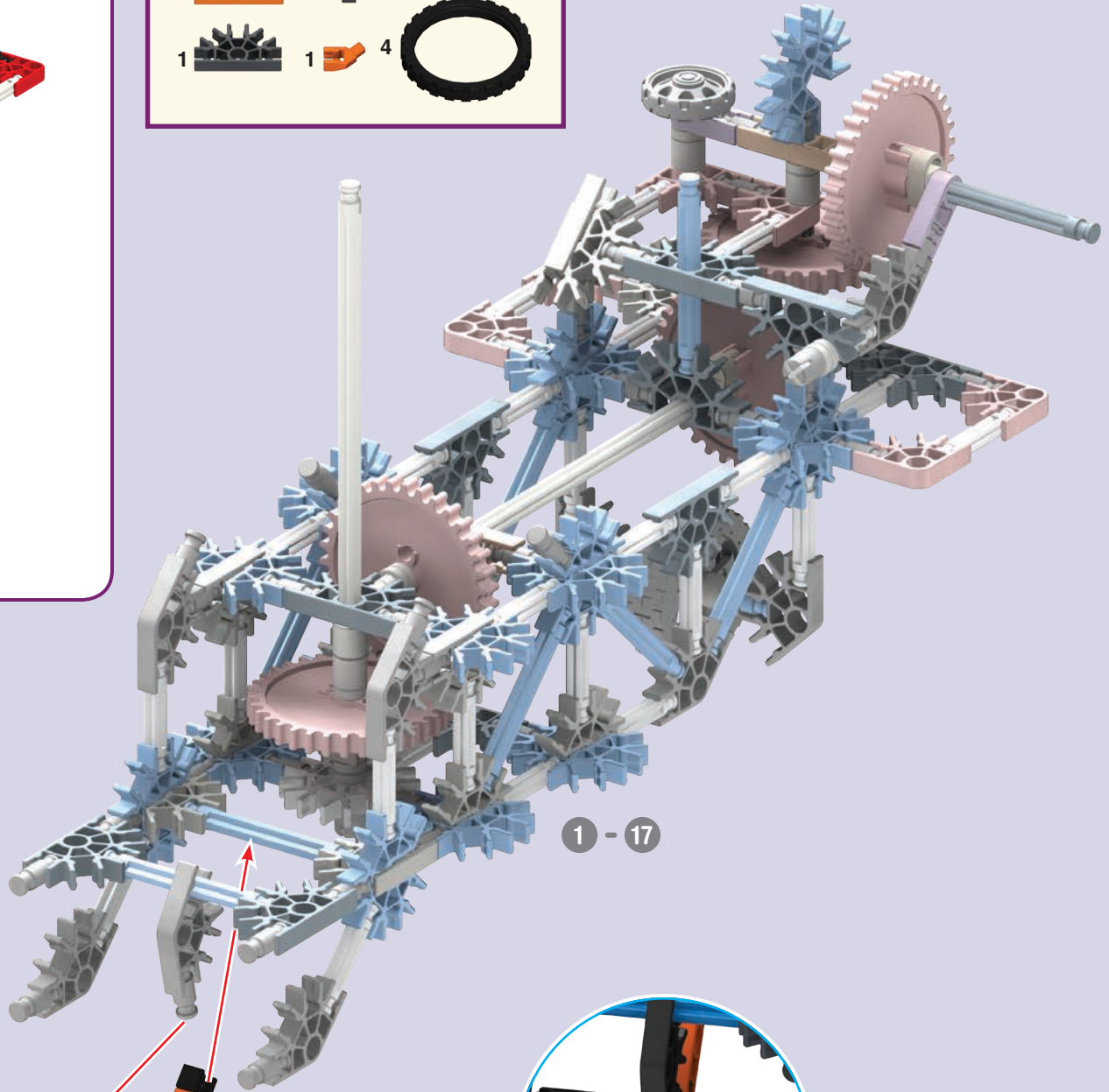
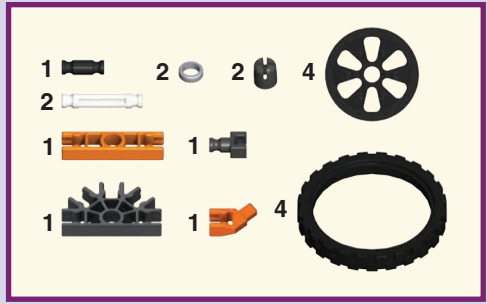

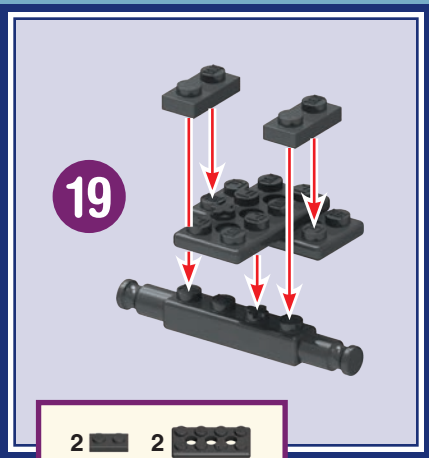

19

- 2
- 2
- 1

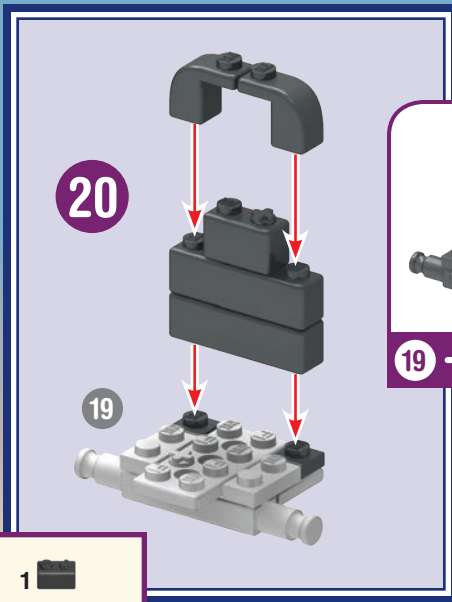

20

- 2
- 1
- 2
- 2



19 - 20

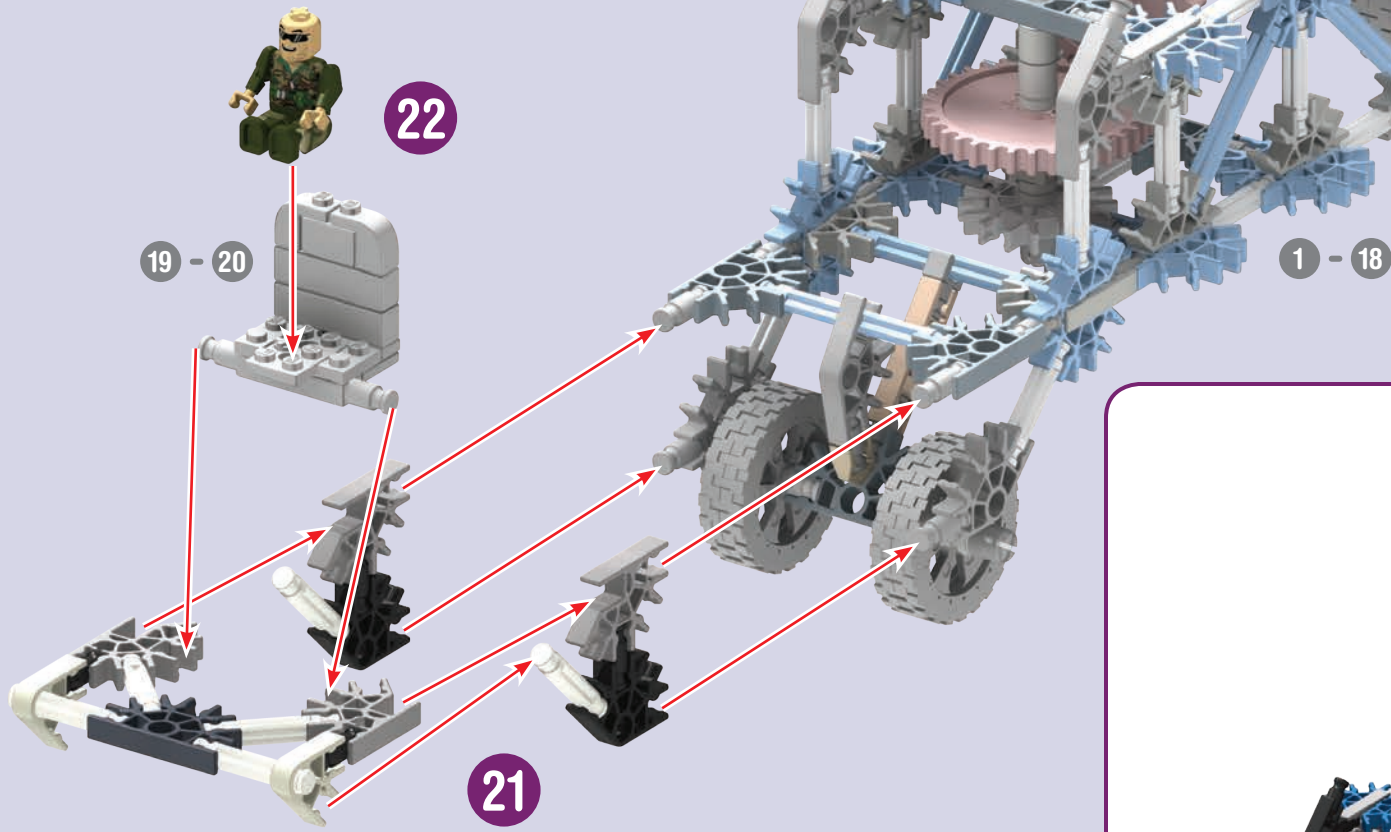

22

19 - 20

1 - 18

21

- 1
- 1
- 1
- 4
- 6
- 1
- 2
- 2
- 1
- 4



1 - 22

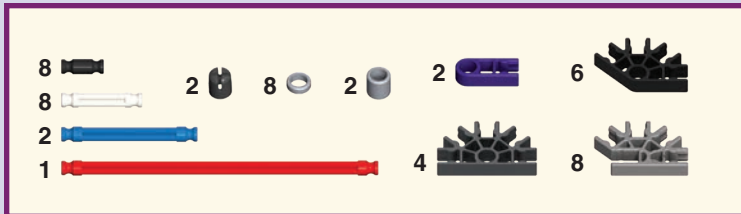
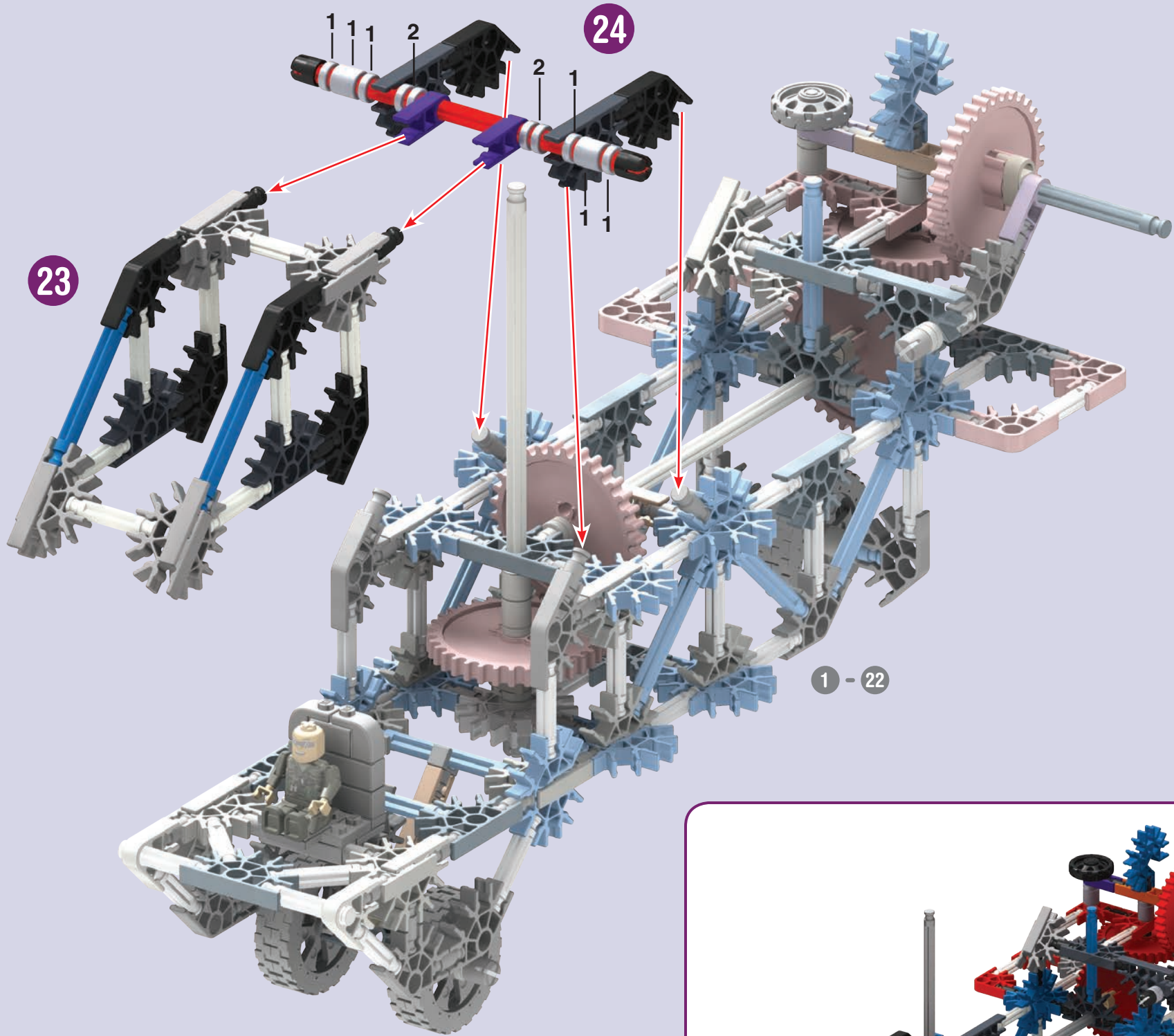

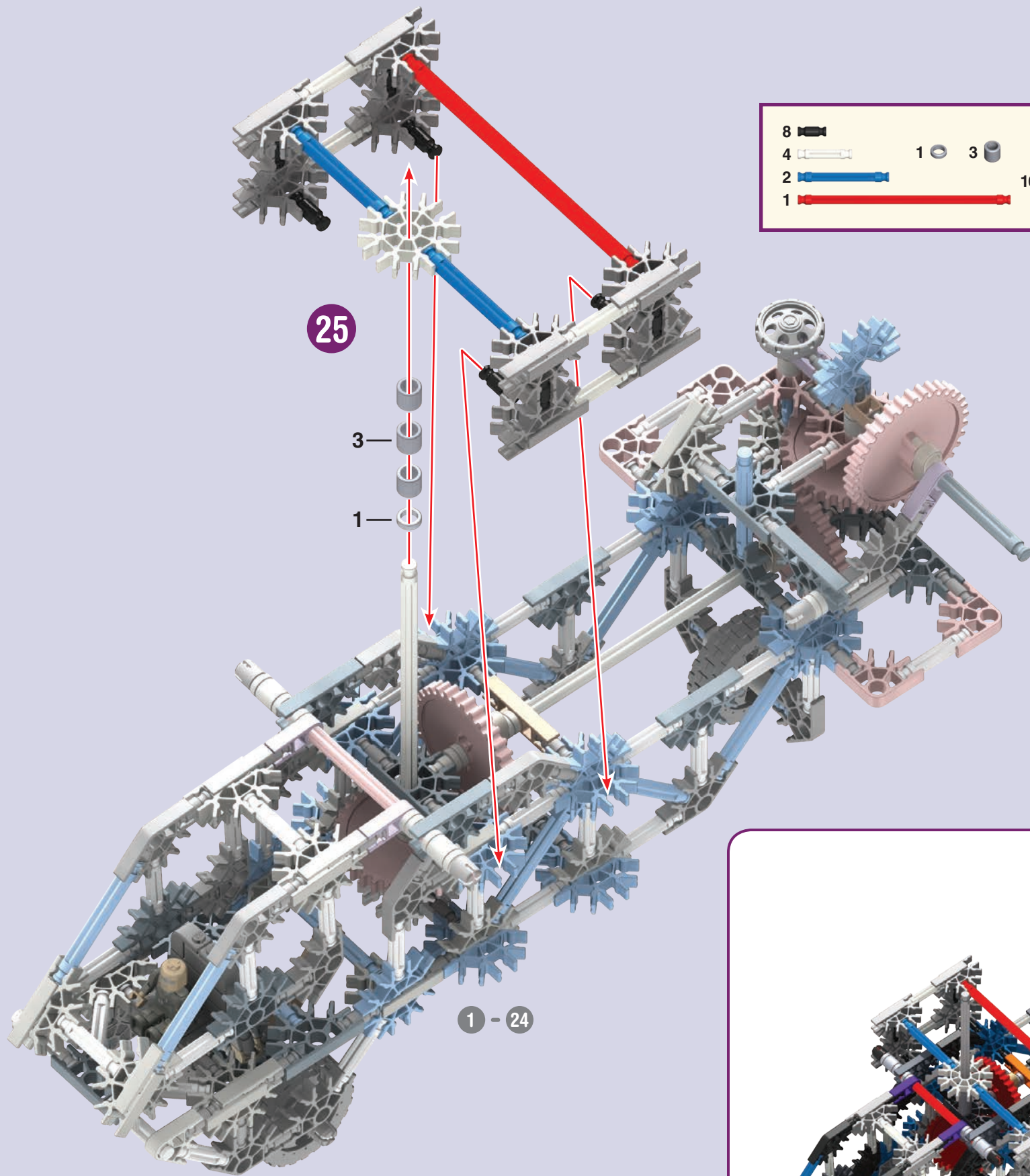

8		1		3		16		1	
4									
2									
1									





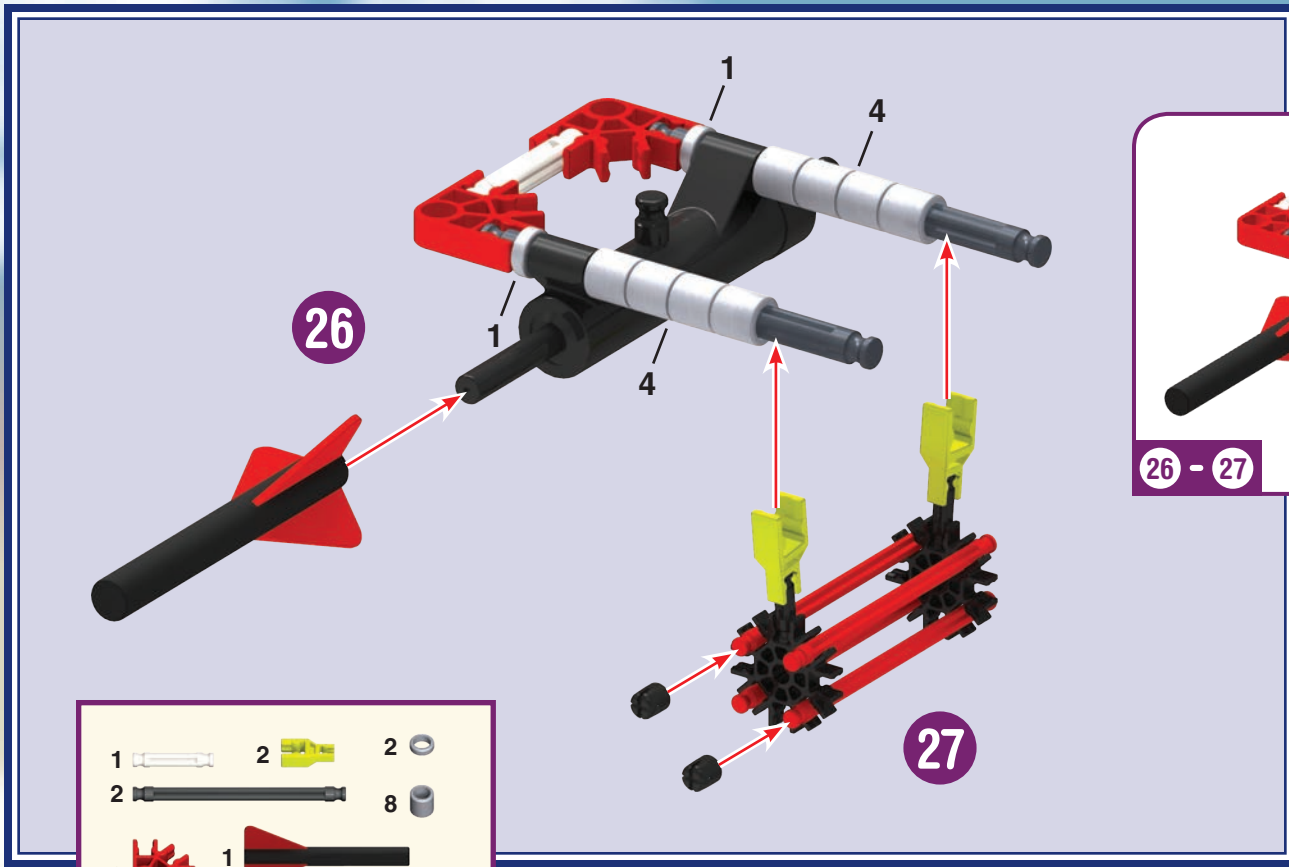

- |   |   |   |
|---|---|---|
| 1 | 2 | 2 |
| 2 |   | 8 |
| 2 | 1 |   |
| 2 | 1 |   |
| 2 |   |   |
| 4 | 2 |   |

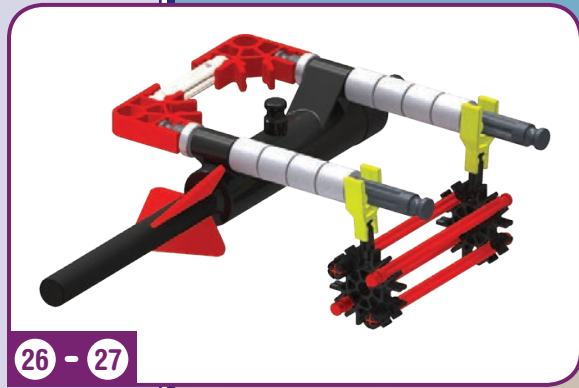

26 - 27

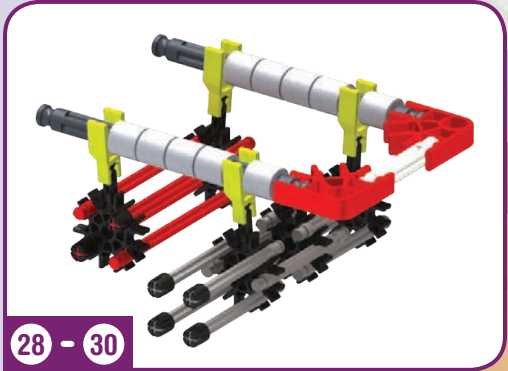
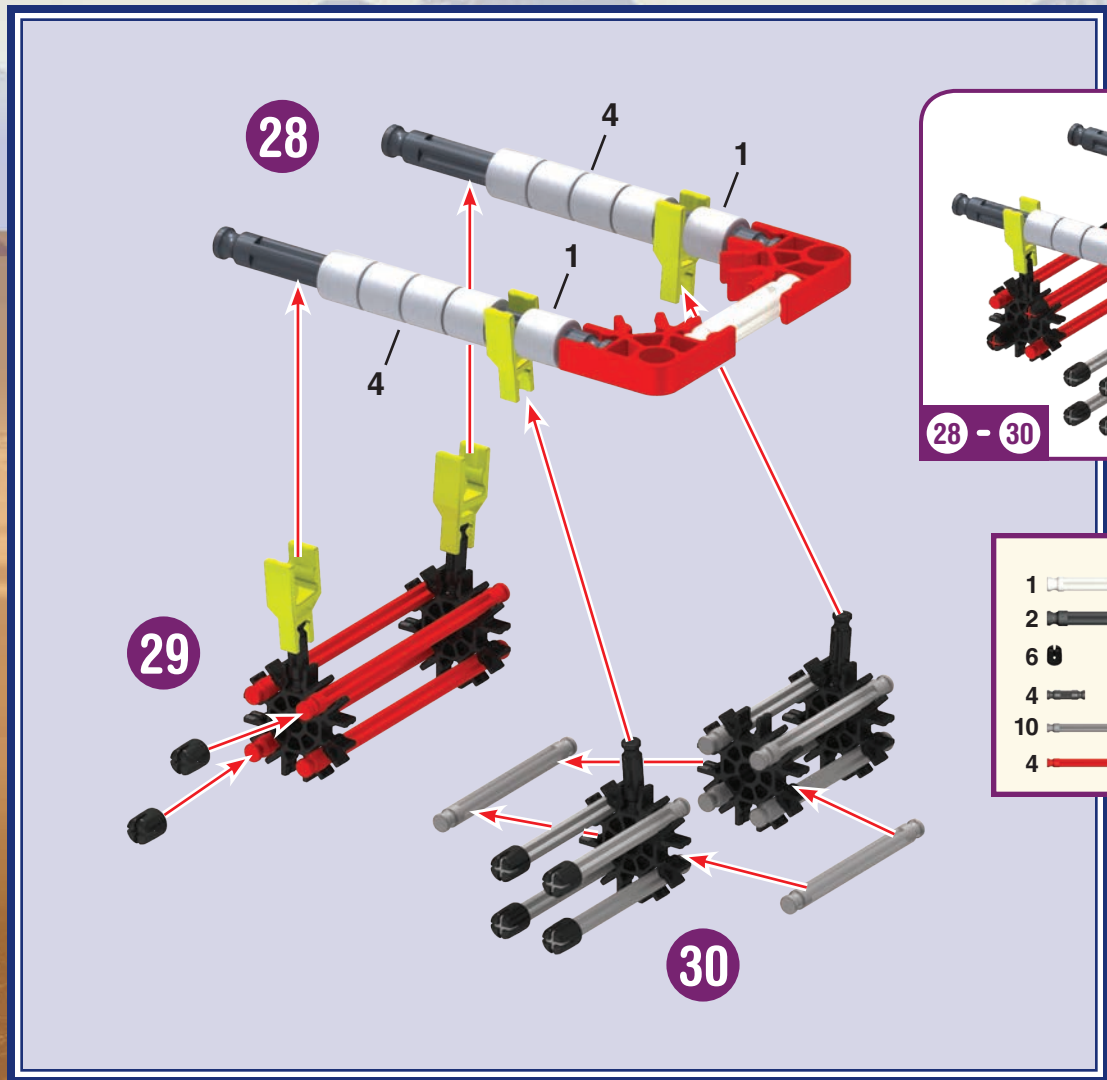

28 - 30

- |    |    |
|----|----|
| 1  | 10 |
| 2  |    |
| 6  | 2  |
| 4  | 4  |
| 10 | 5  |
| 4  |    |

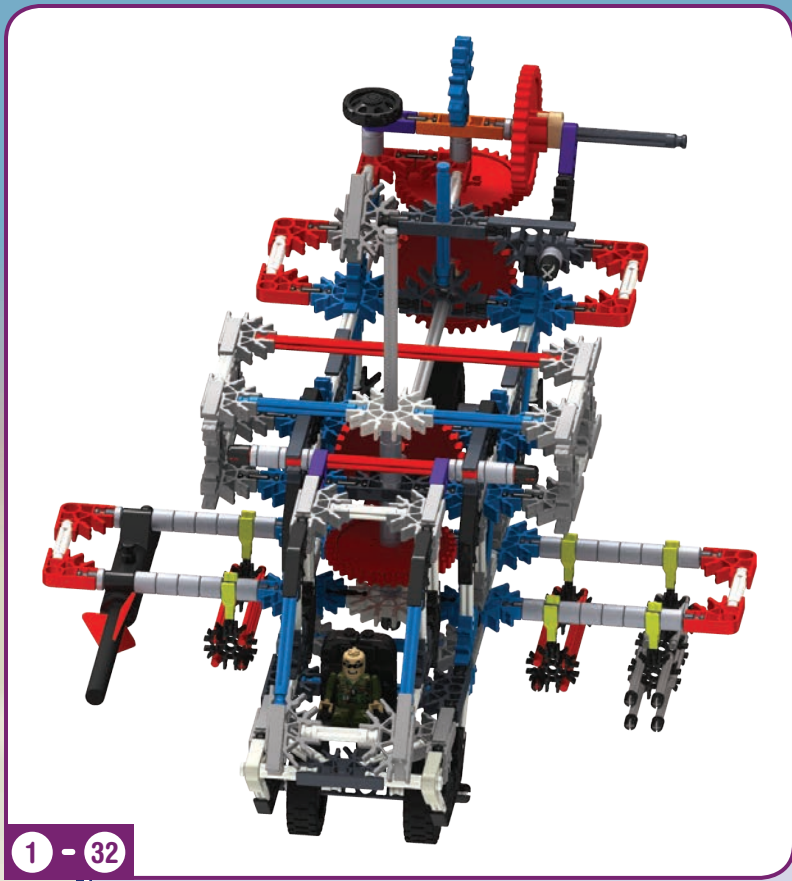

1 - 32



4

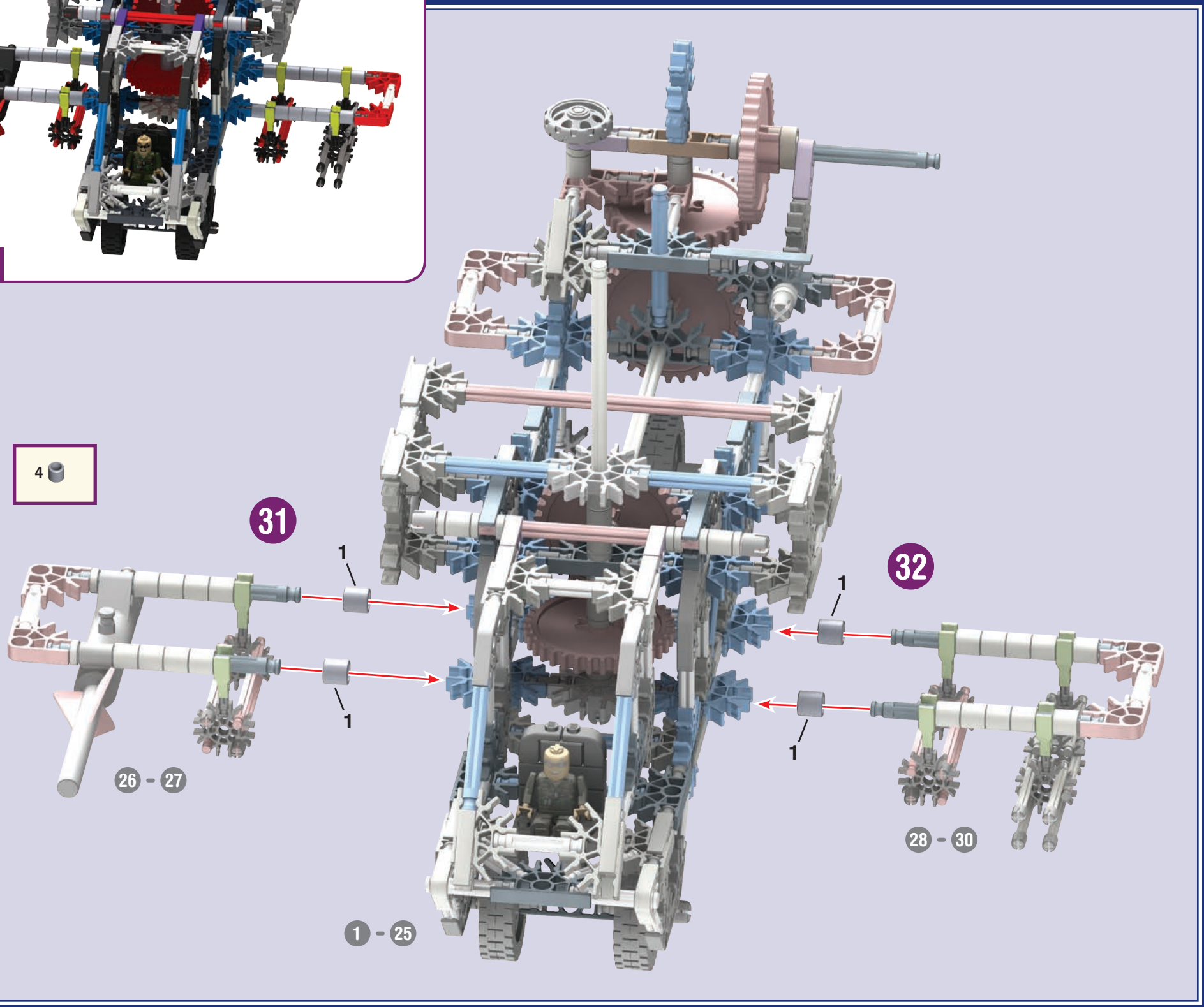

26 - 27

31

32

28 - 30

1 - 25

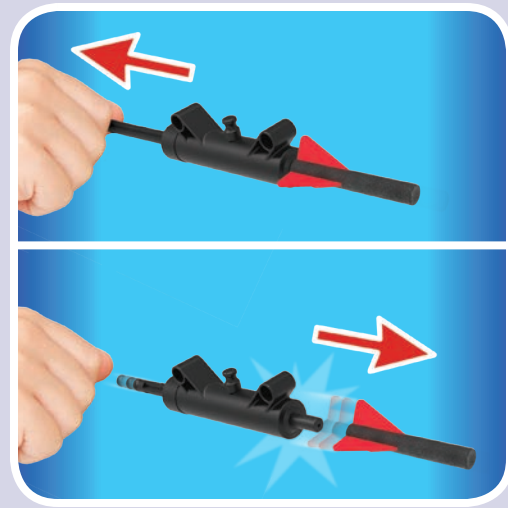
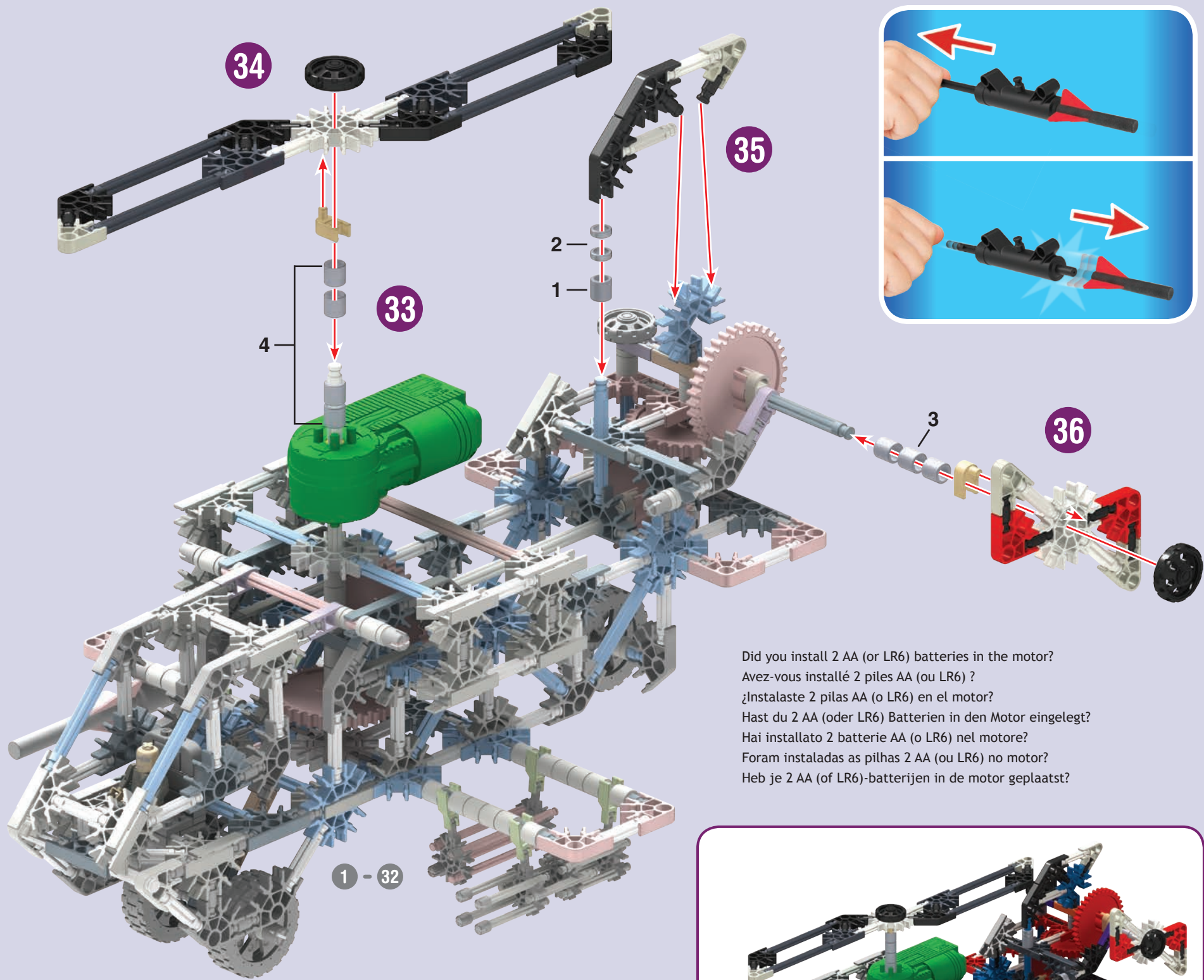

Did you install 2 AA (or LR6) batteries in the motor?  
 Avez-vous installé 2 piles AA (ou LR6) ?  
 ¿Instalaste 2 pilas AA (o LR6) en el motor?  
 Hast du 2 AA (oder LR6) Batterien in den Motor eingelegt?  
 Hai installato 2 batterie AA (o LR6) nel motore?  
 Foram instaladas as pilhas 2 AA (ou LR6) no motor?  
 Heb je 2 AA (of LR6)-batterijen in de motor geplaatst?

- |    |  |   |  |   |  |   |  |  |
|----|--|---|--|---|--|---|--|--|
| 13 |  | 2 |  | 8 |  | 2 |  |  |
| 6  |  | 4 |  | 5 |  | 2 |  |  |
| 4  |  | 2 |  | 2 |  | 1 |  |  |
| 2  |  | 6 |  | 2 |  |   |  |  |





**COMBAT CREW  
5-IN-1  
SATELLITE  
DEFENSE  
VEHICLE**



**ÉQUIPE DE COMBAT  
5-EN-1  
VÉHICULE DE  
LA DÉFENSE  
PAR SATELLITE**





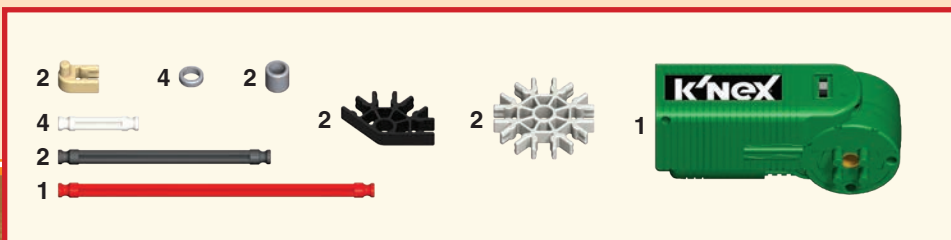
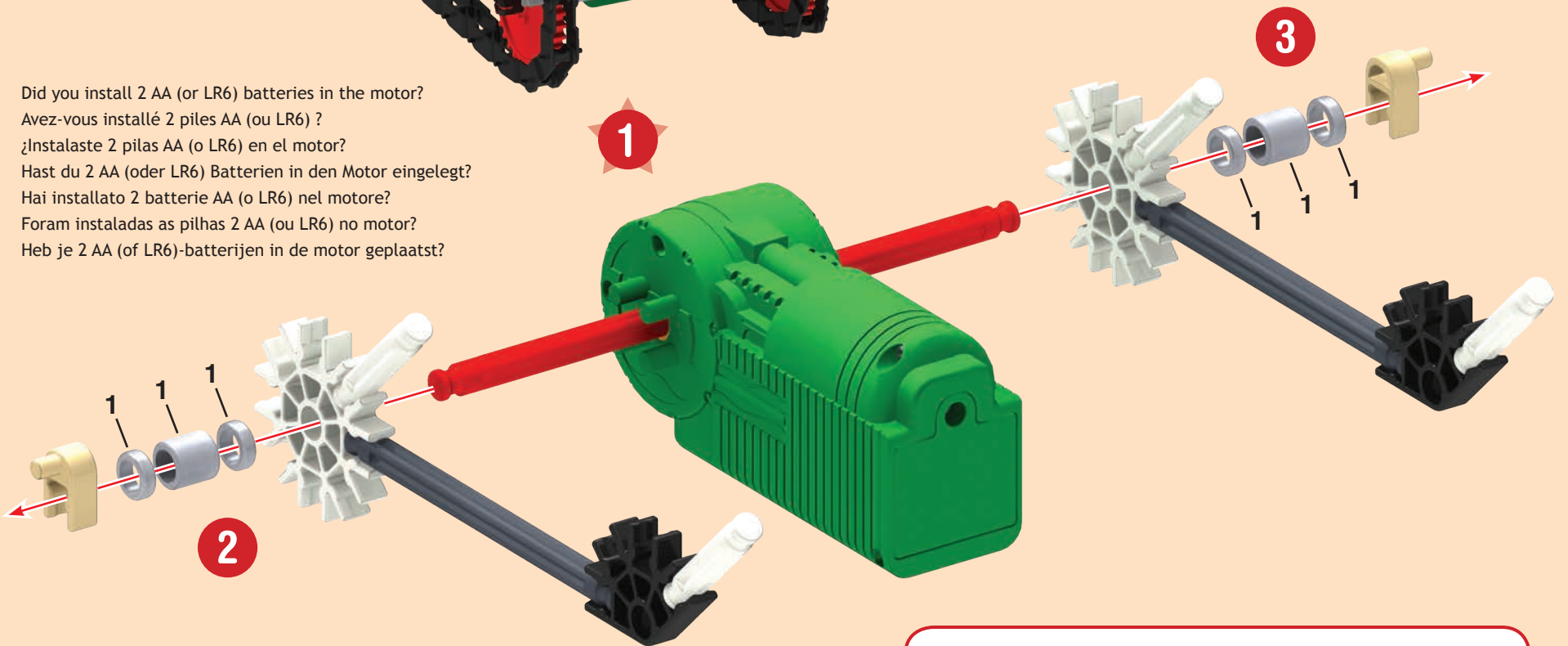

**Builds 2  
at once!  
Constuire 2  
à la fois !**

Did you install 2 AA (or LR6) batteries in the motor?  
Avez-vous installé 2 piles AA (ou LR6) ?  
¿Instalaste 2 pilas AA (o LR6) en el motor?  
Hast du 2 AA (oder LR6) Batterien in den Motor eingelegt?  
Hai installato 2 batterie AA (o LR6) nel motore?  
Foram instaladas as pilhas 2 AA (ou LR6) no motor?  
Heb je 2 AA (of LR6)-batterijen in de motor geplaatst?

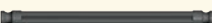

1 - 3

- 4 
- 3 
- 1 
- 2  8 

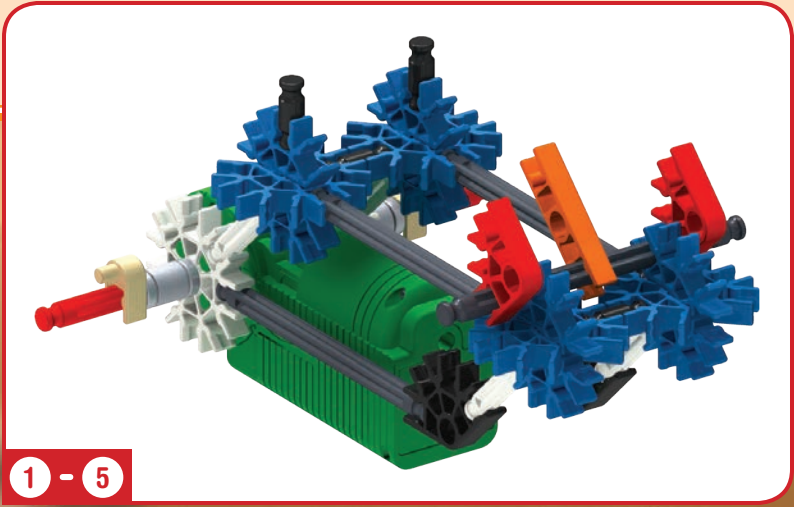
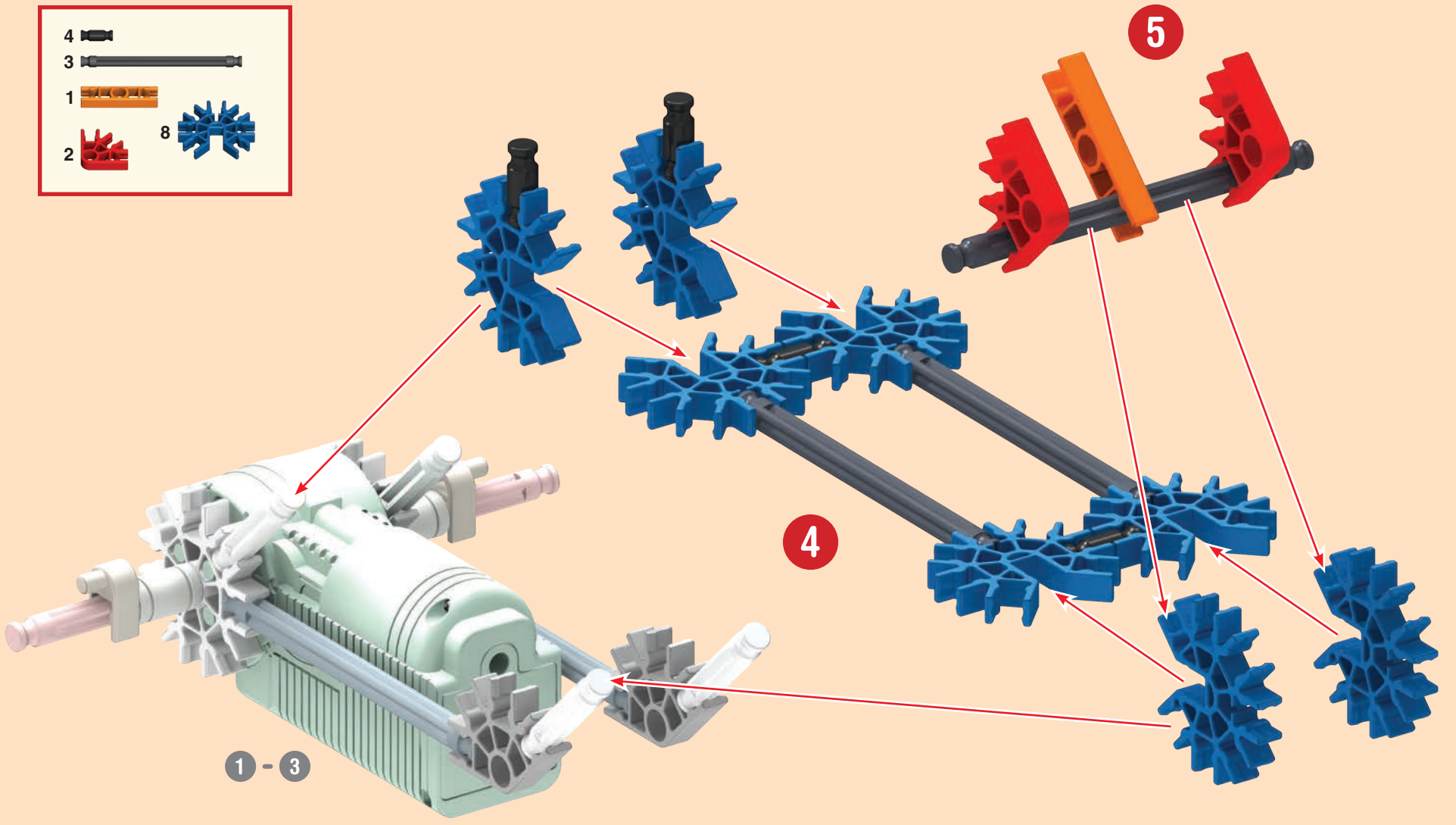

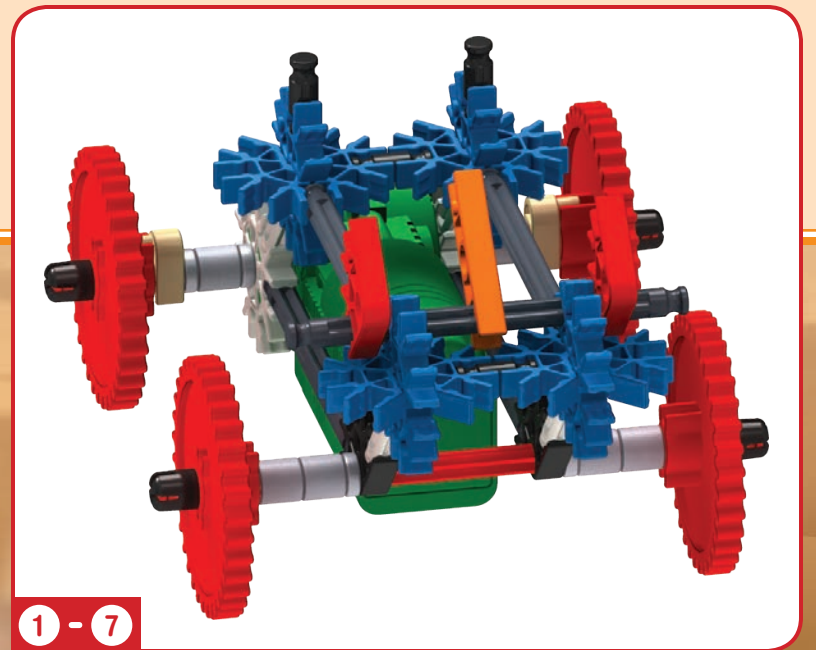
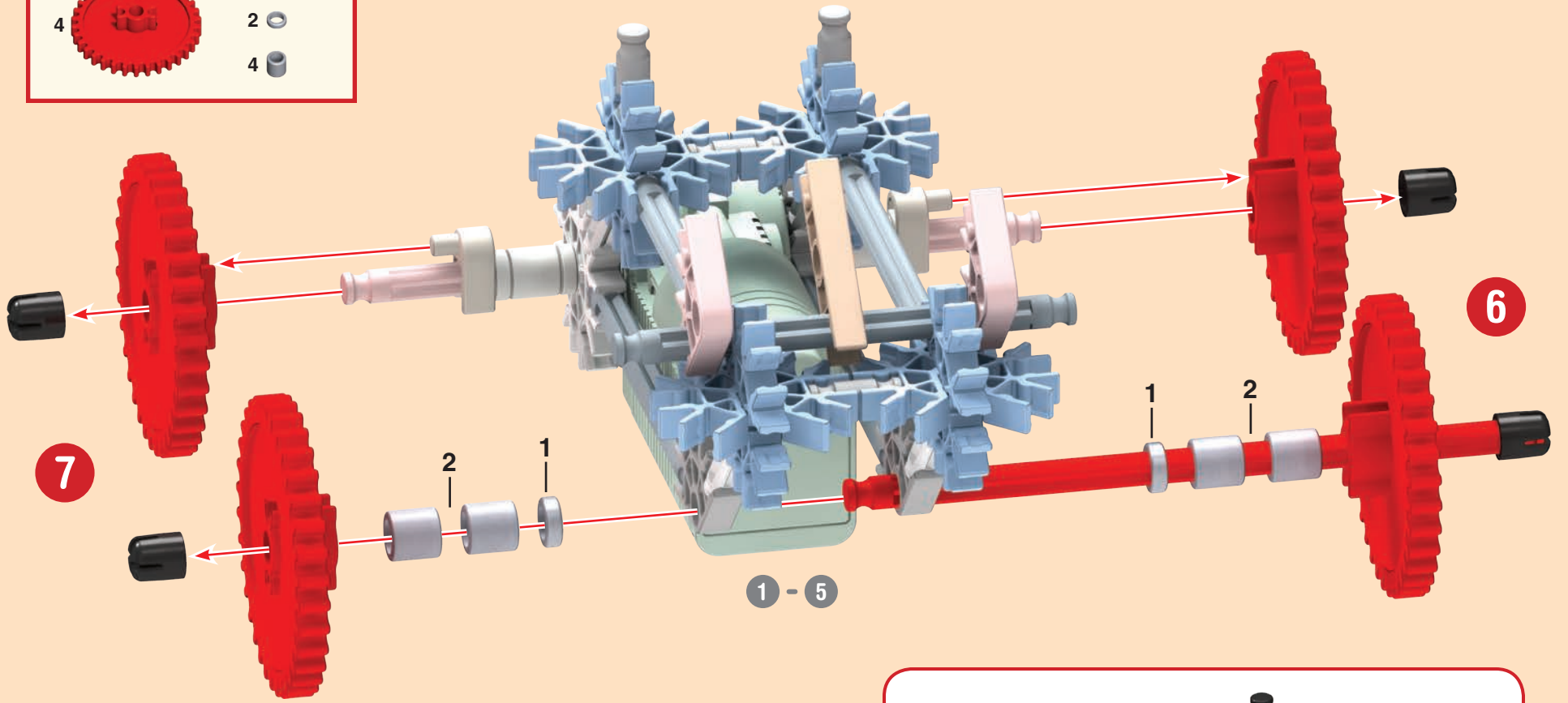
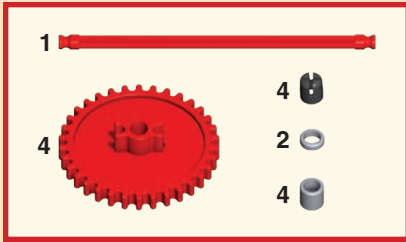

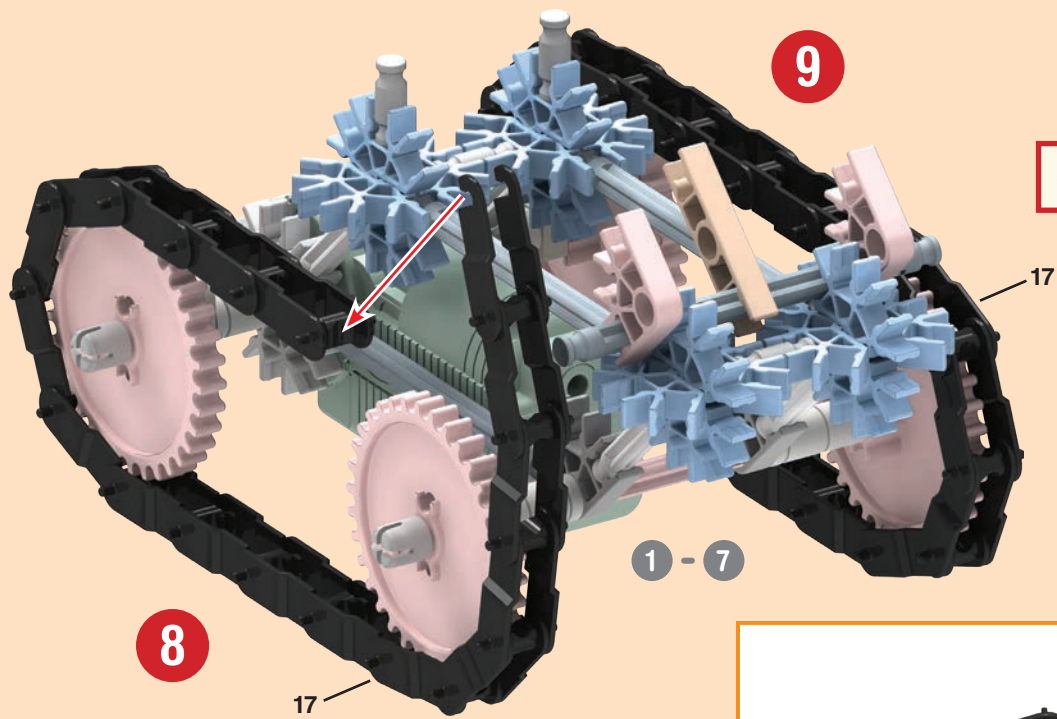

34

1 - 9



**IMPORTANT:** Attach all the chain links in the same direction.

**IMPORTANT :** Assure-toi de fixer tous les maillons de la chaîne dans le même sens.

**IMPORTANTE:** Asegúrate de fijar todos los elementos de la cadena en la misma dirección.

**WICHTIG:** Achte darauf, alle Kettenglieder in der gleichen Richtung zu verbinden.

**IMPORTANTE:** Accertati di attaccare tutti i collegamenti della catena nella stessa direzione.

**IMPORTANTE:** Assegura-te que conectar todos os elos da corrente seguindo a mesma direcção.

**BELANGRIJK:** Maak zeker dat alle ketenschakels vastgemaakt worden in dezelfde richting.

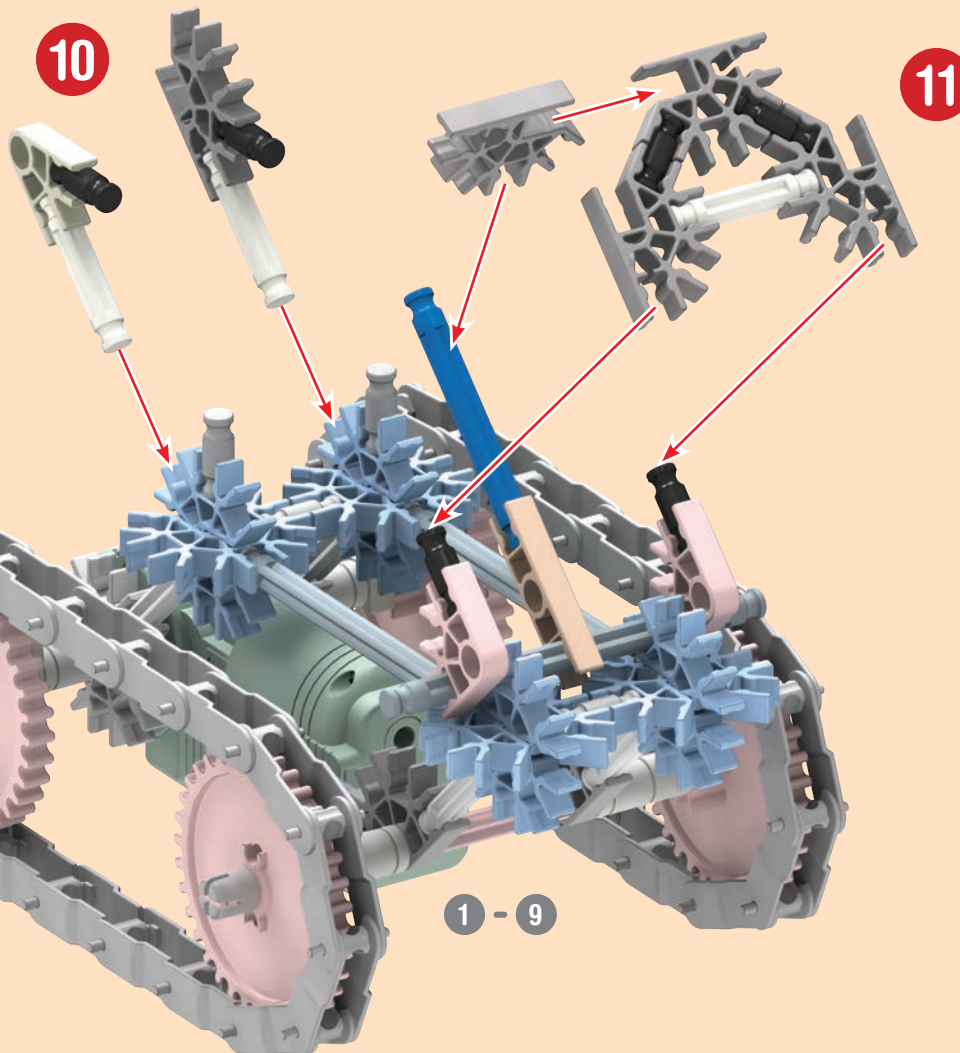

6

3

1

1

5

1 - 11



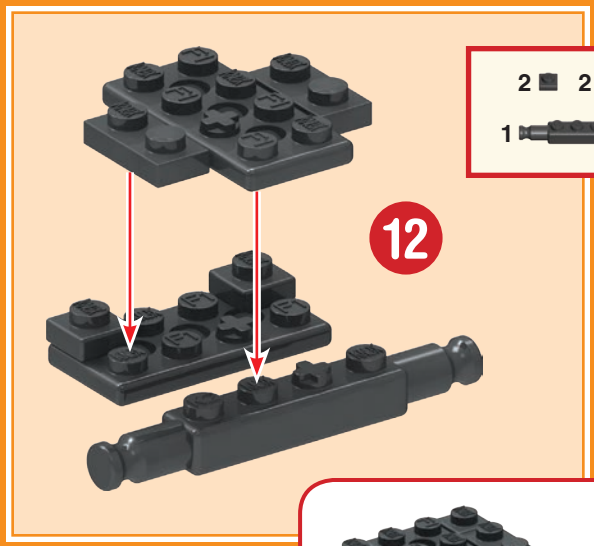

- 2
- 2
- 1
- 2

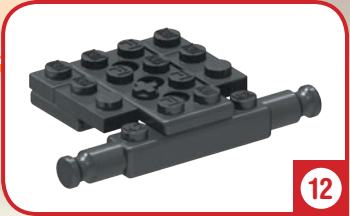

12

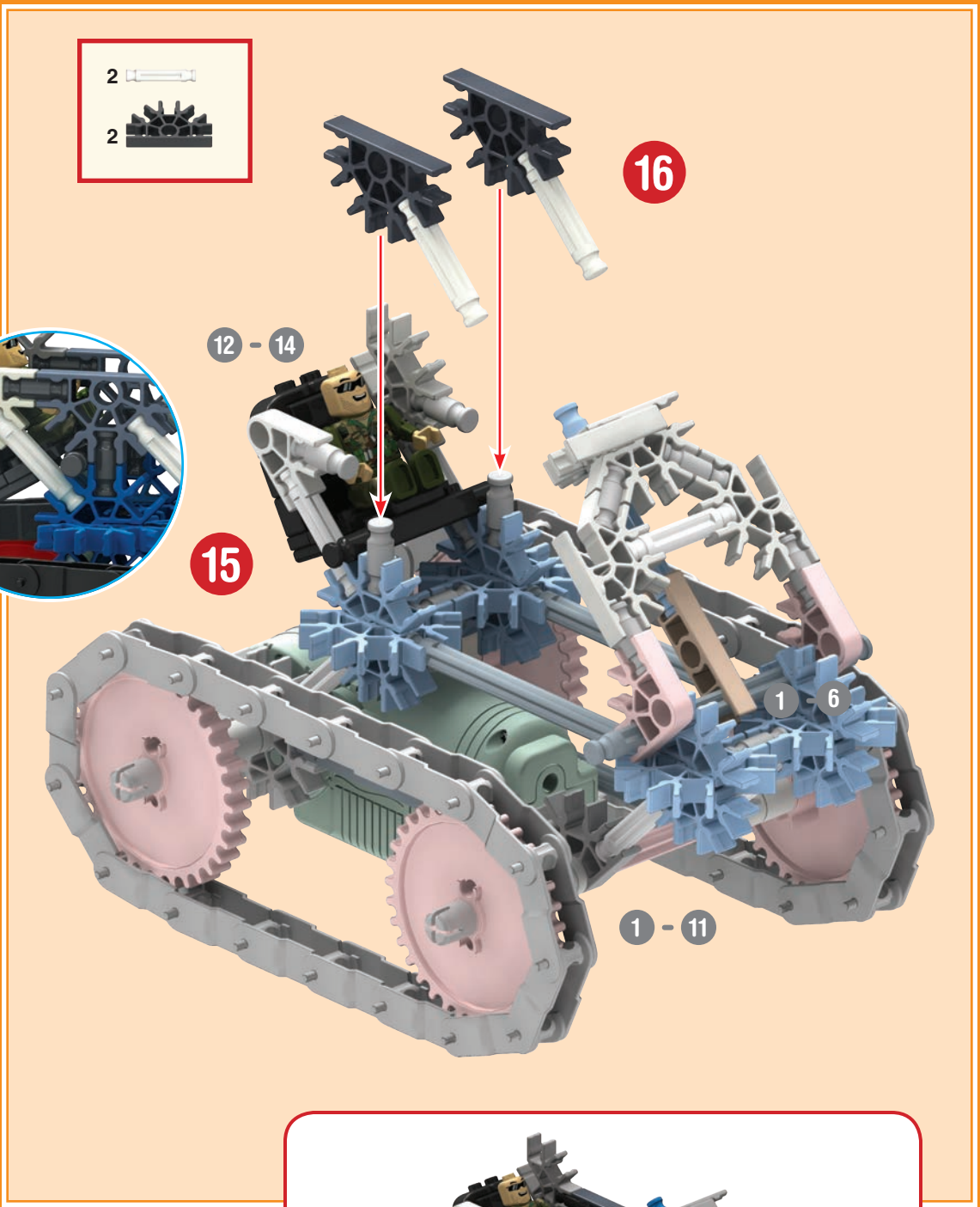

- 2
- 2

16

12 - 14

15

1 6

1 - 11



- 1
- 1
- 1
- 1
- 2
- 1
- 2

14

13

12



12 - 14



1 - 16



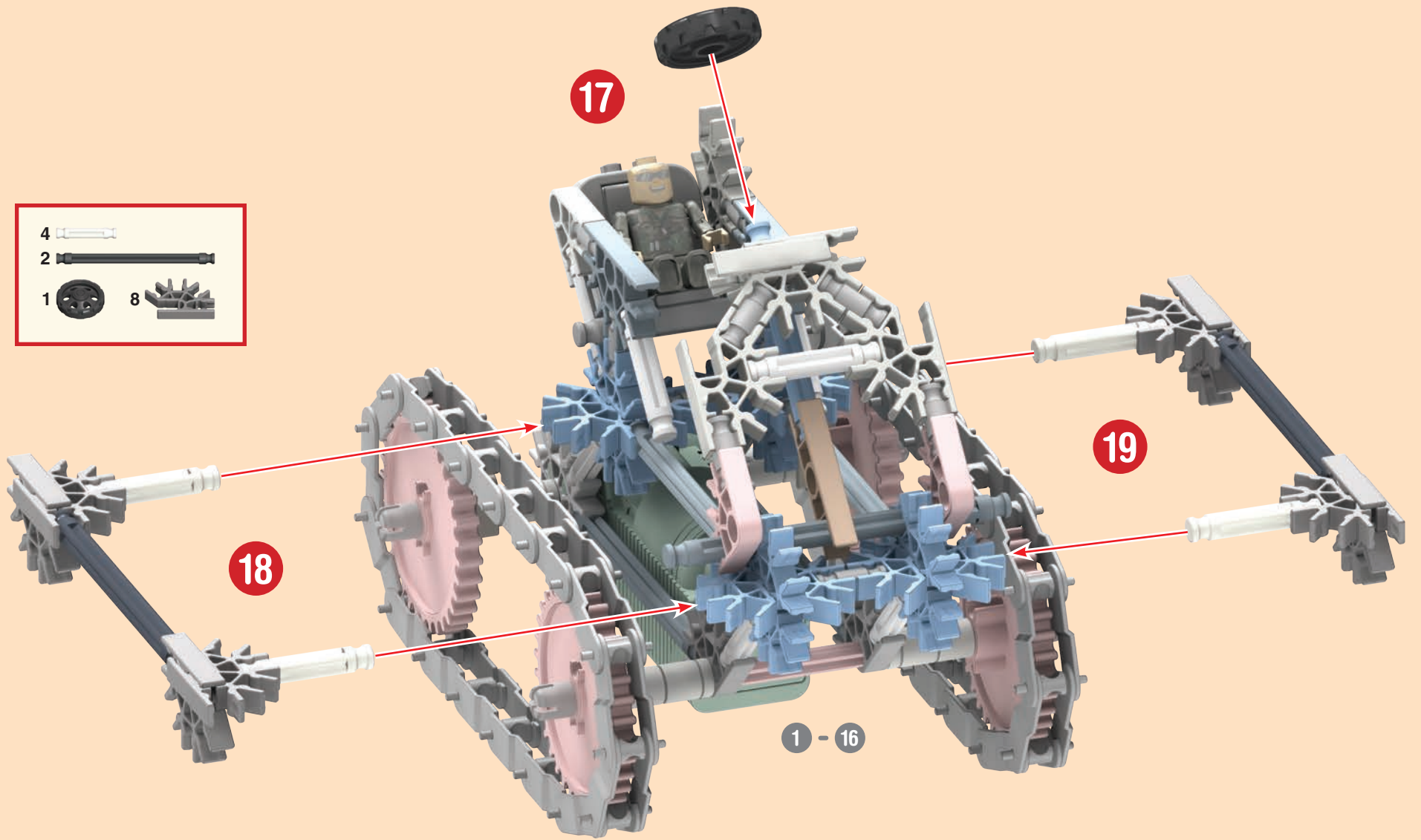
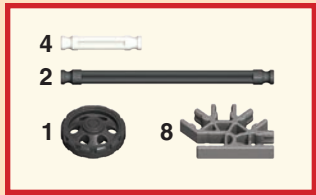

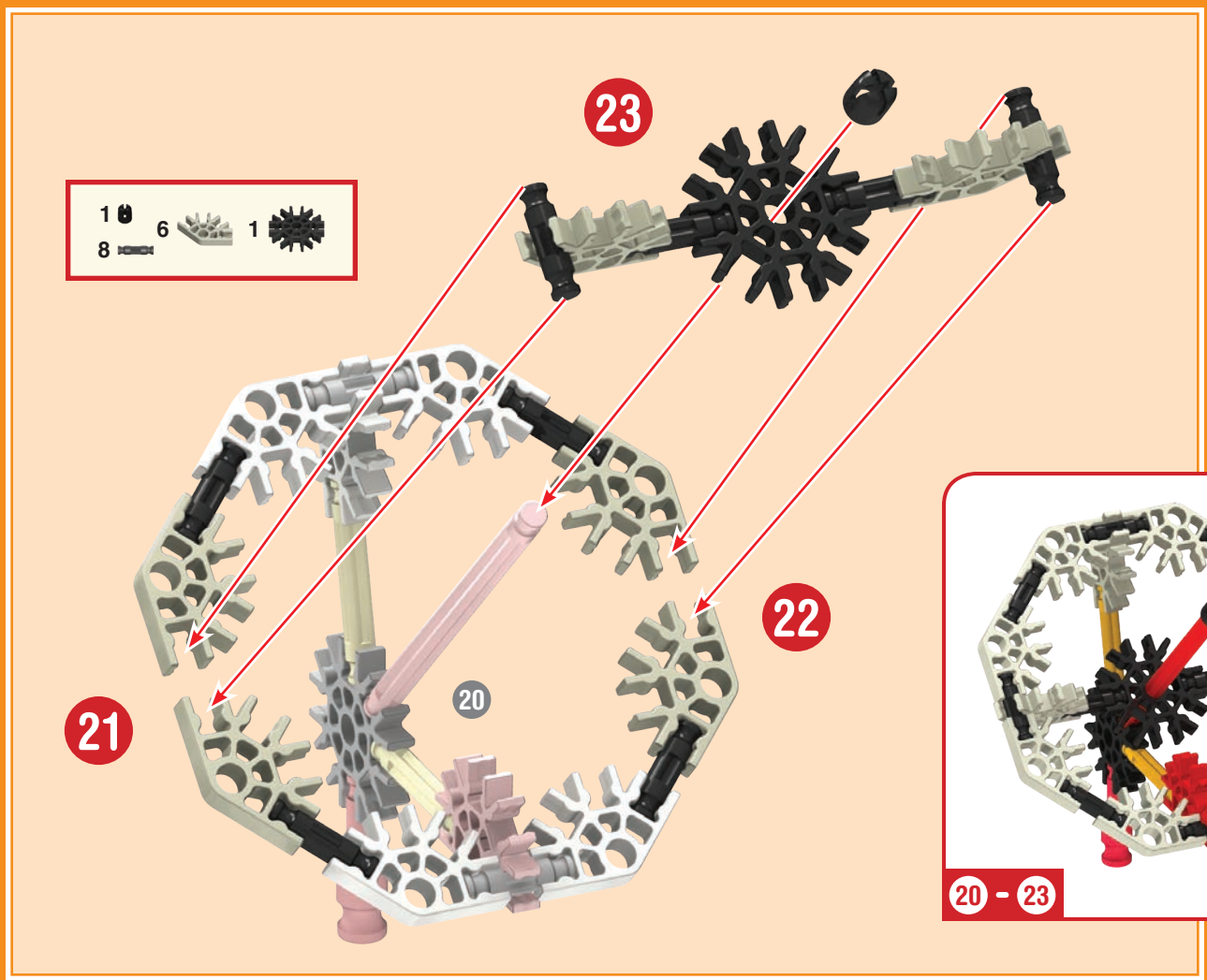
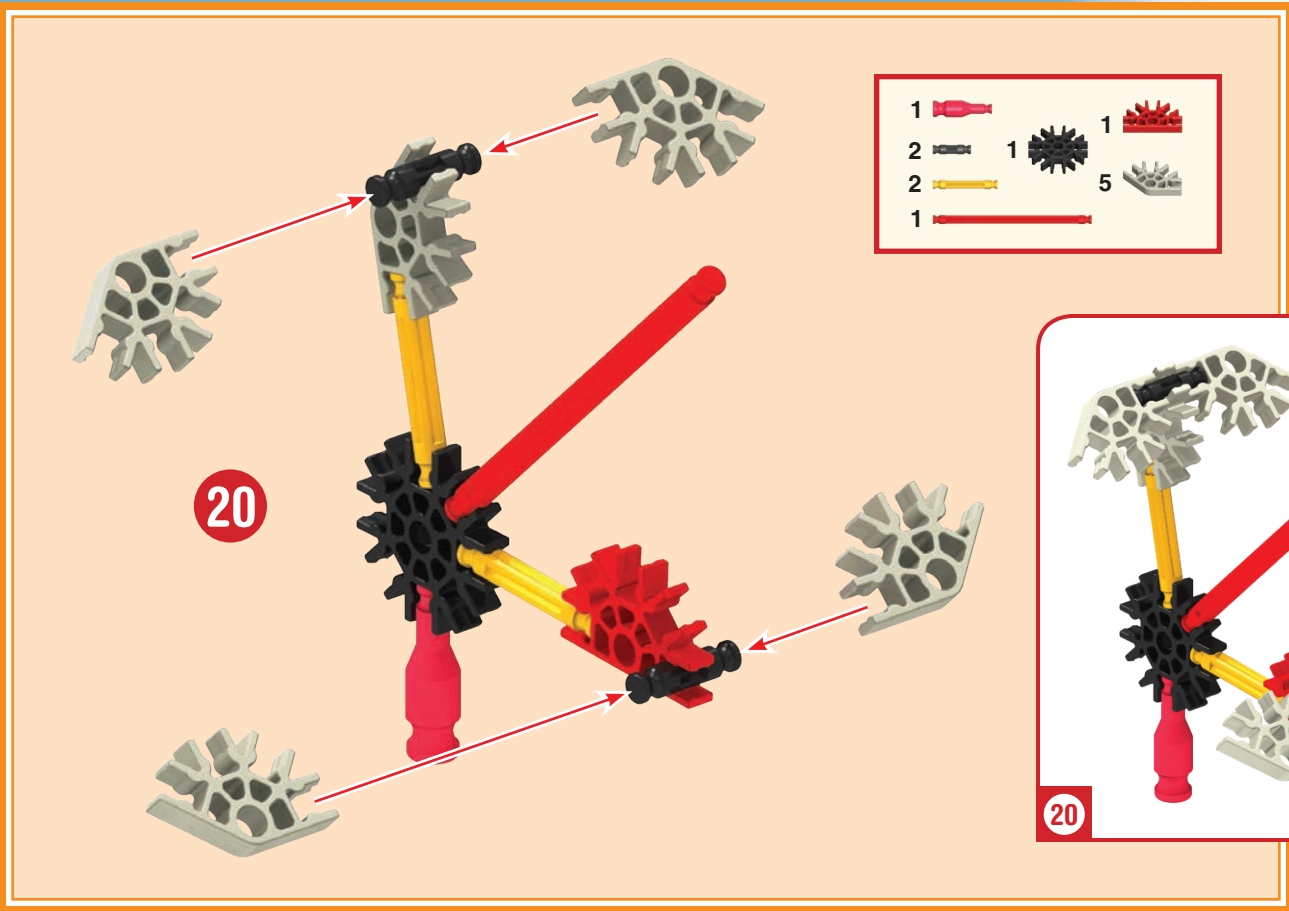

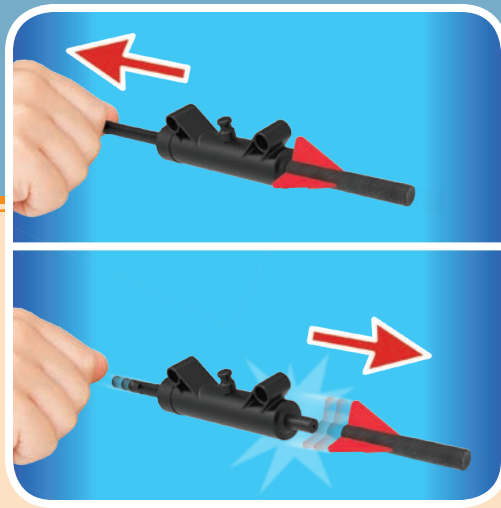

- |   |  |   |  |   |  |   |  |
|---|--|---|--|---|--|---|--|
| 1 |  | 1 |  | 1 |  | 7 |  |
| 4 |  |   |  |   |  |   |  |
| 1 |  |   |  |   |  |   |  |
| 1 |  |   |  |   |  |   |  |
| 1 |  |   |  |   |  |   |  |
| 1 |  |   |  |   |  |   |  |
| 1 |  |   |  |   |  |   |  |
| 1 |  |   |  |   |  |   |  |
| 4 |  |   |  |   |  |   |  |

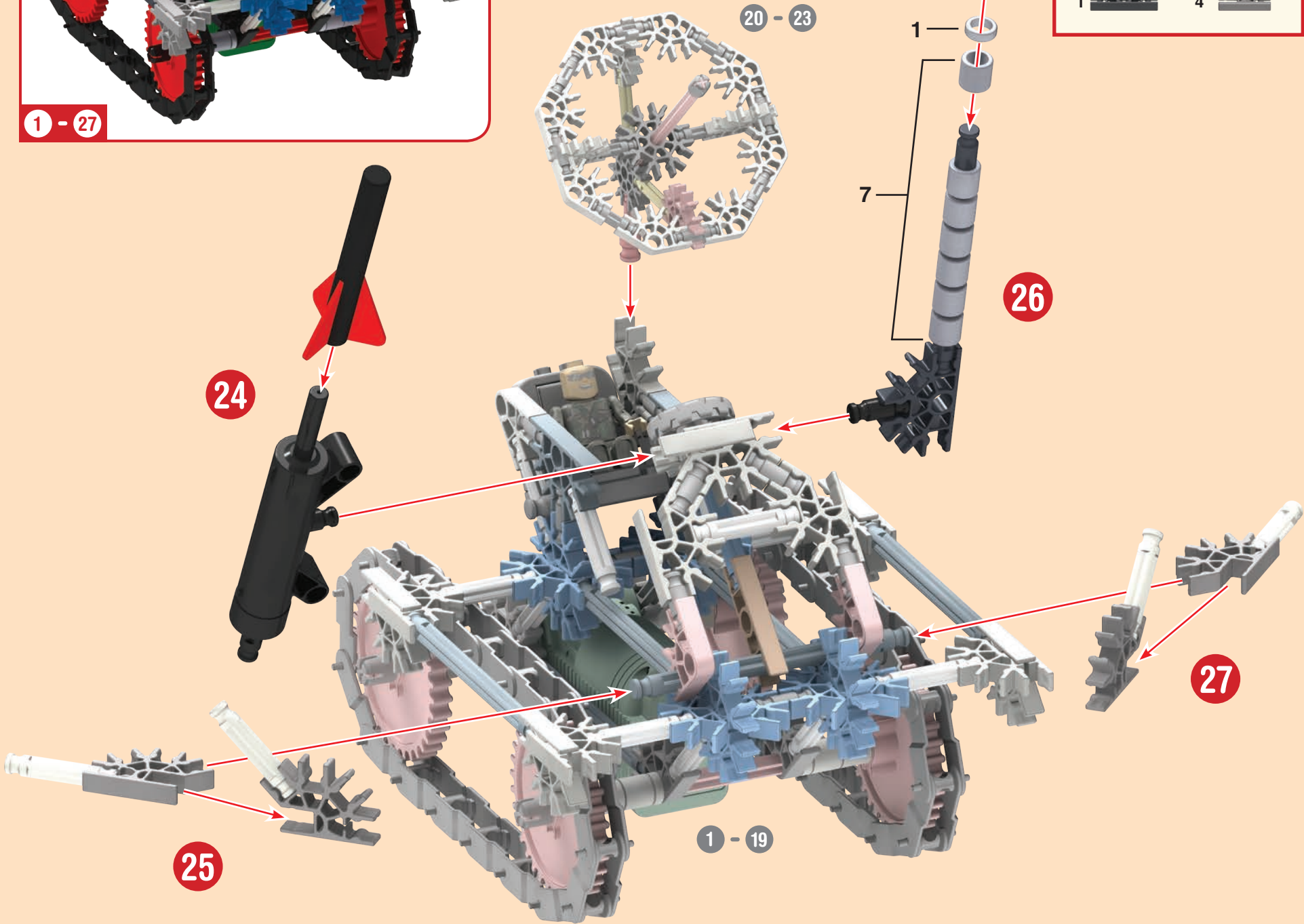



COMBAT CREW  
5-IN-1  
**DRONE**

ÉQUIPE DE COMBAT  
5-EN-1  
**DRONE**

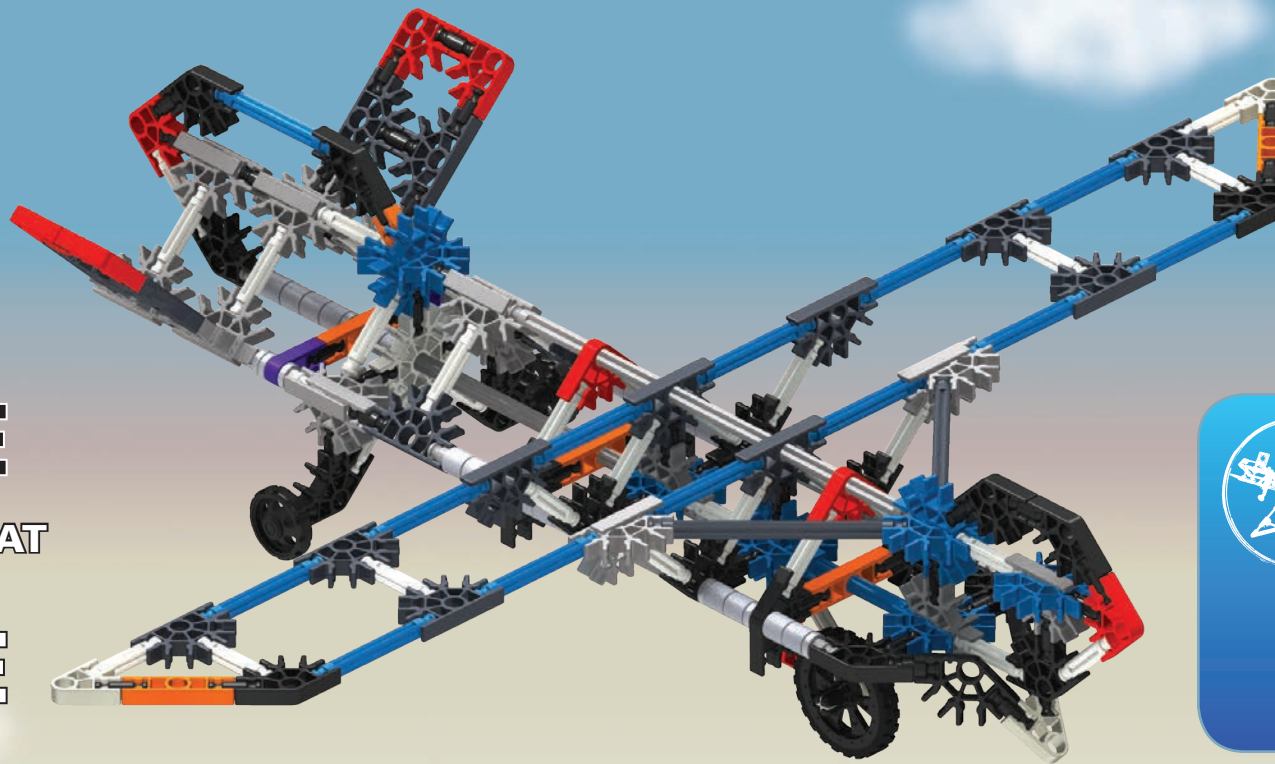

**Builds 2  
at once!**  
**Constuire 2  
à la fois !**

- 1
- 3
- 1
- 1
- 6
- 1

1



- |   |  |   |  |   |  |   |  |   |  |
|---|--|---|--|---|--|---|--|---|--|
| 6 |  | 1 |  | 2 |  | 4 |  | 2 |  |
| 2 |  |   |  |   |  |   |  |   |  |
| 1 |  |   |  |   |  |   |  |   |  |

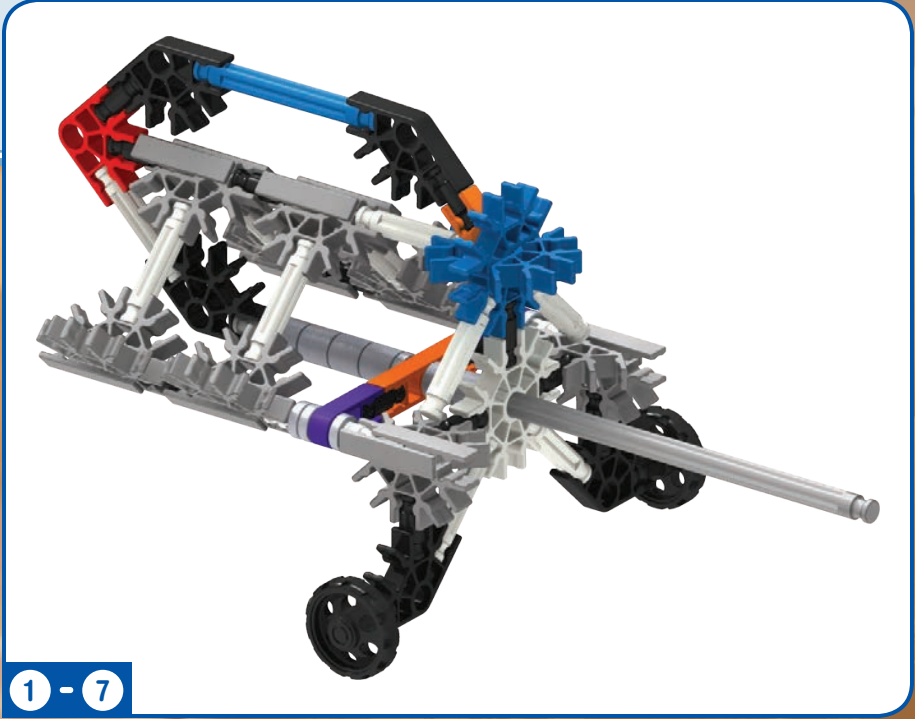
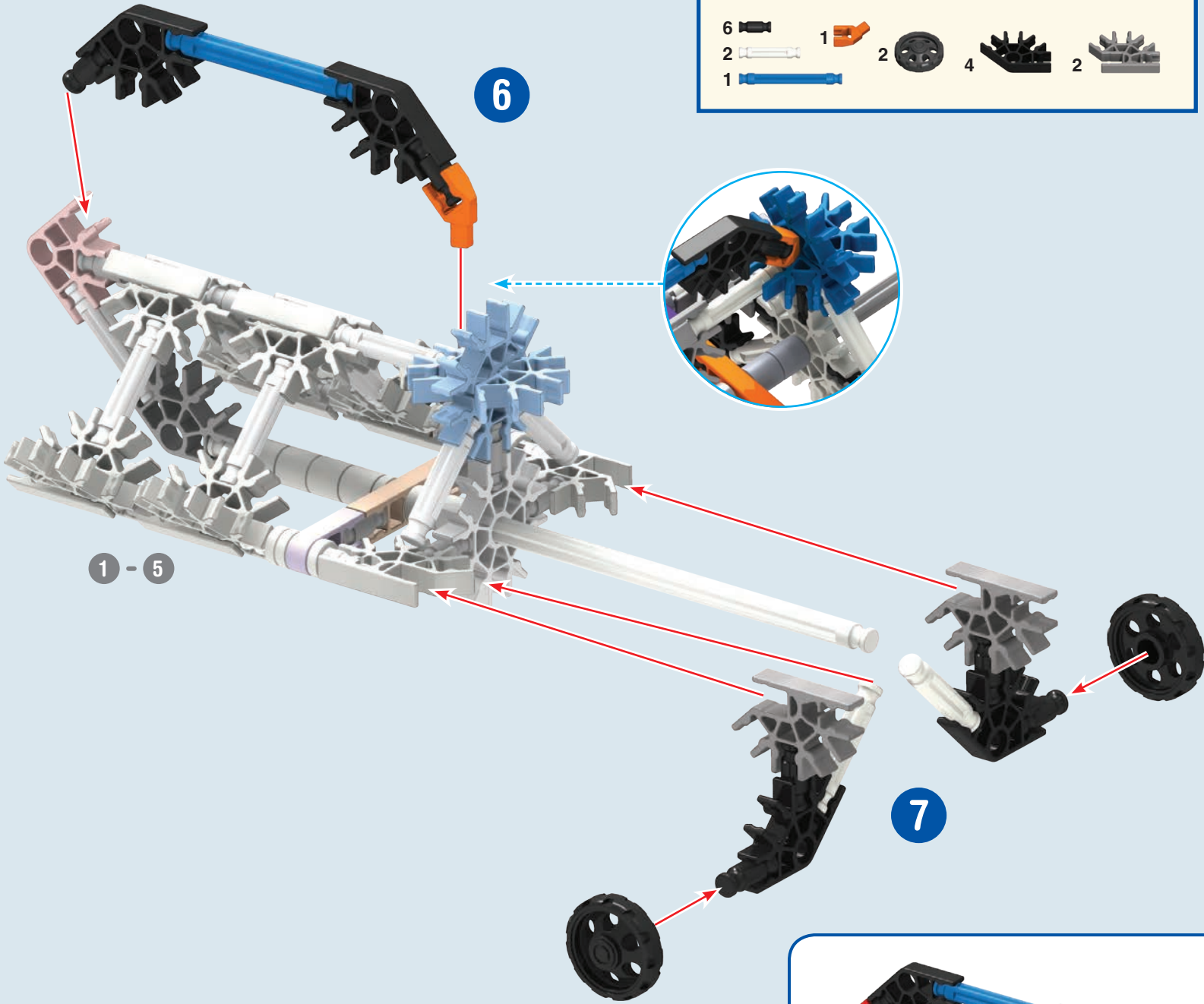

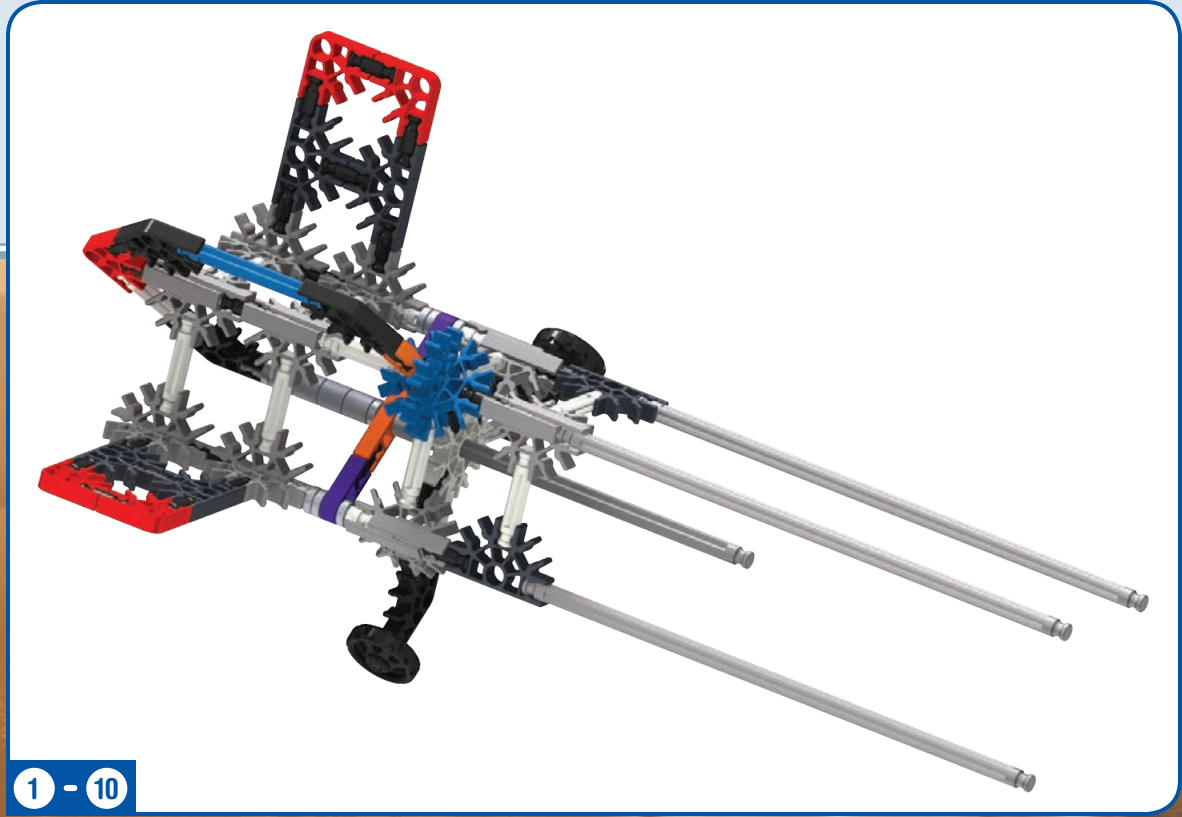
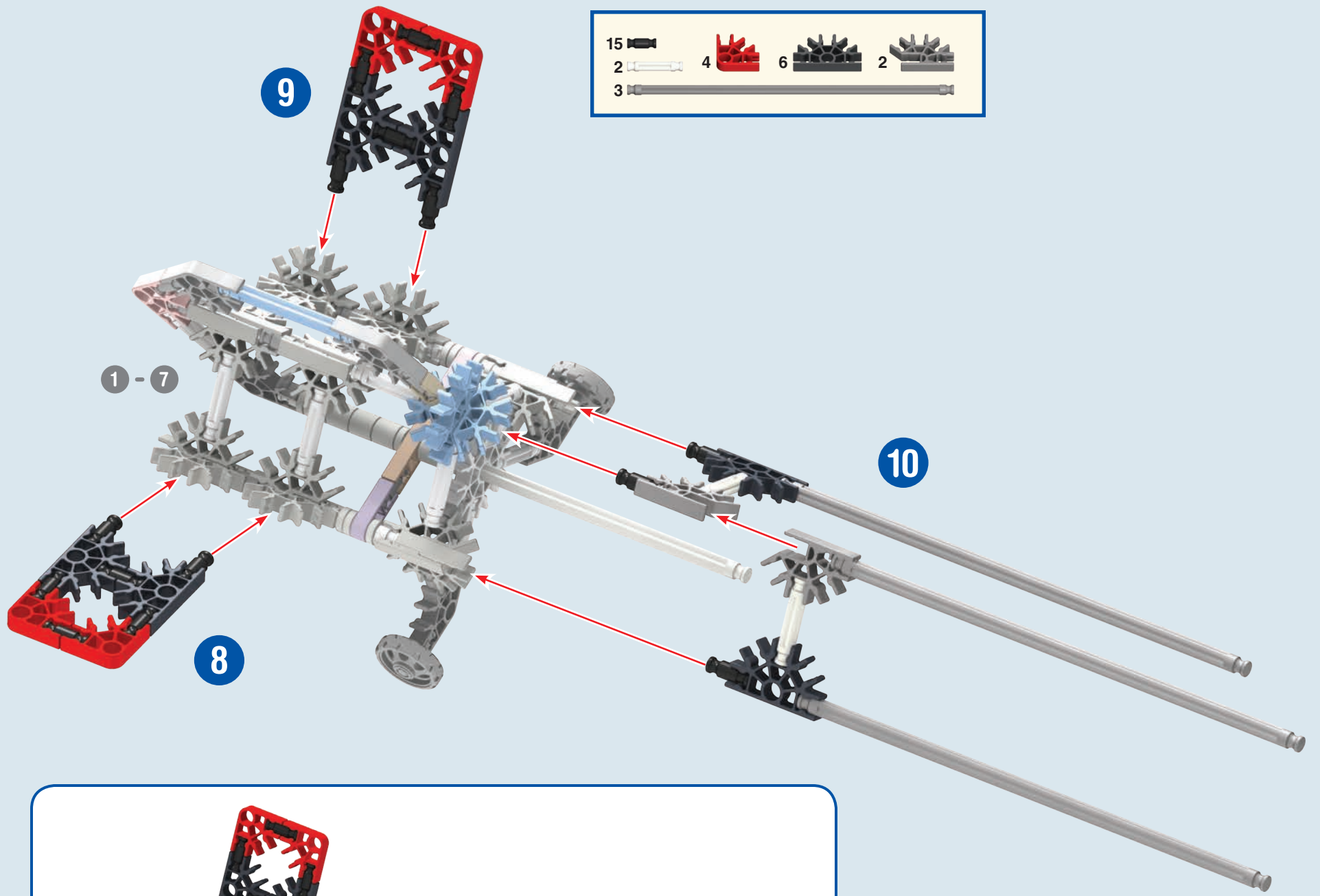
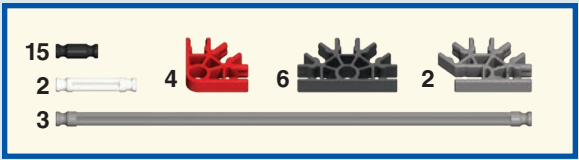

1 - 10

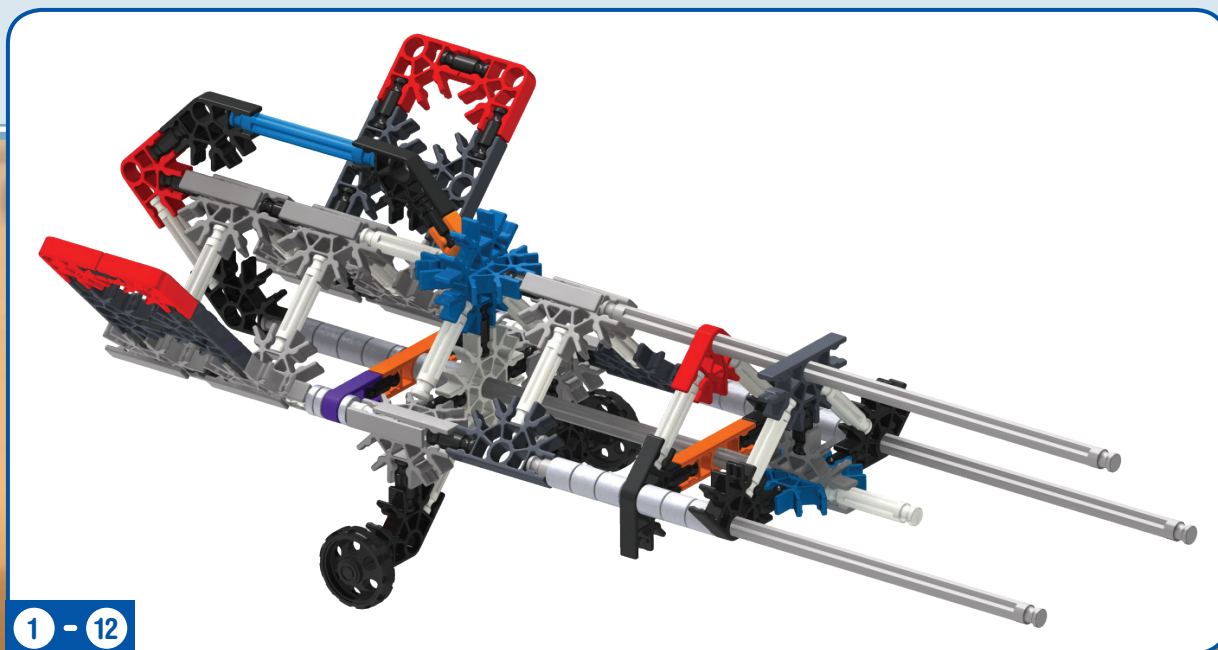
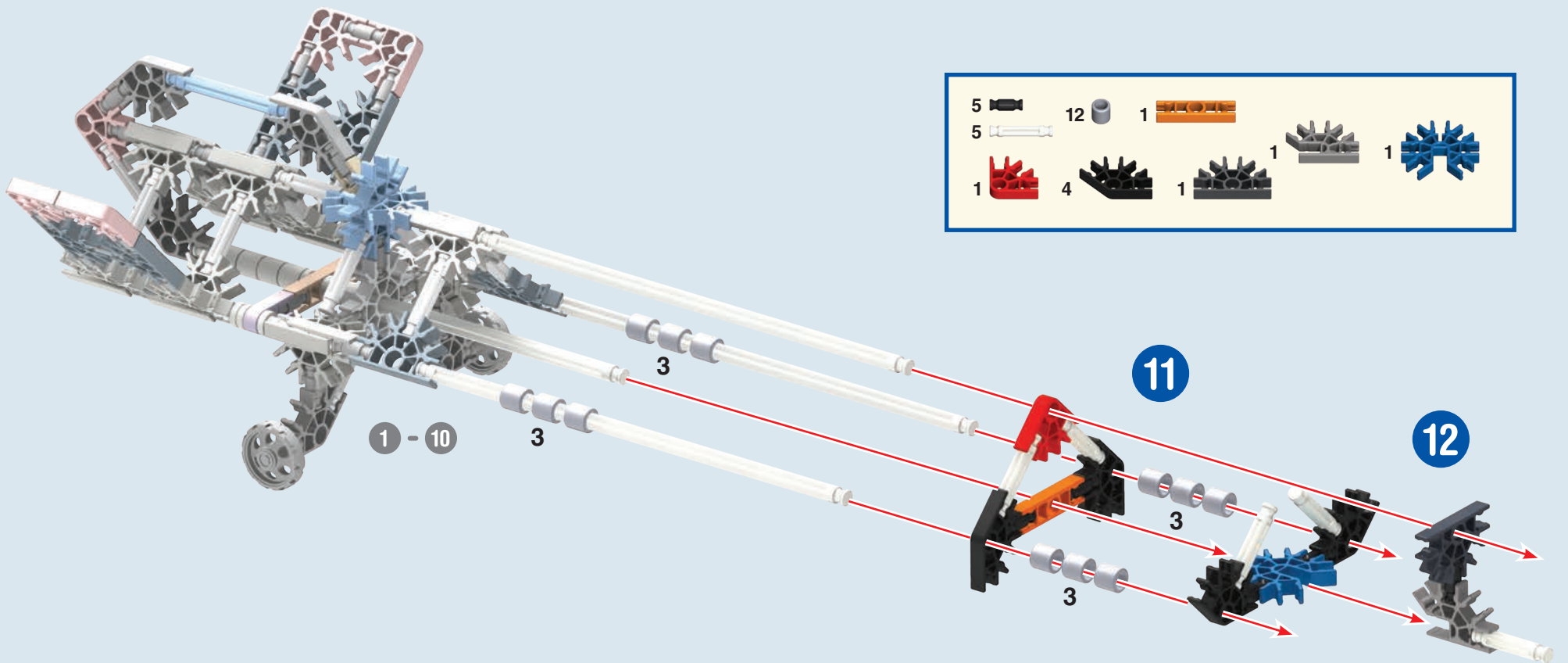



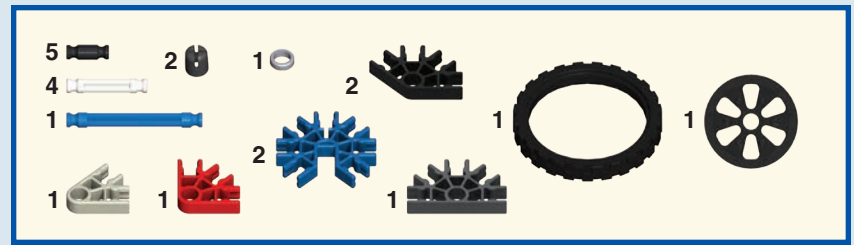
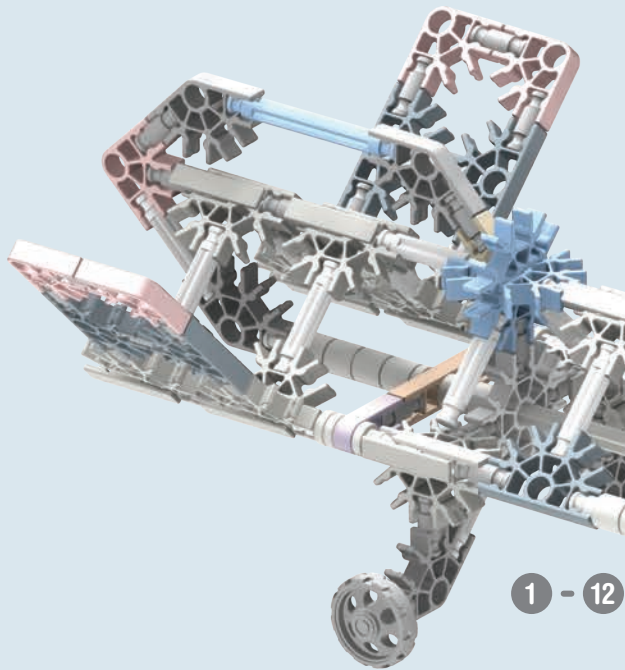

1 - 12

13

14

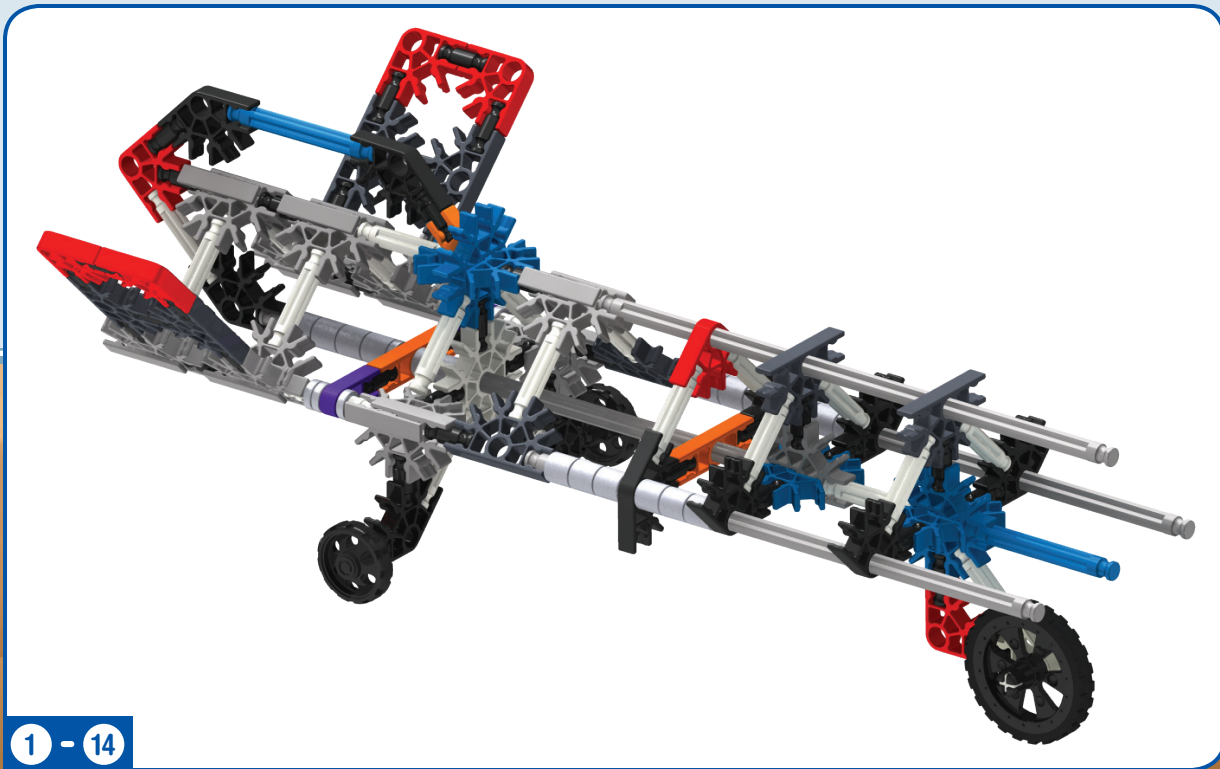

1 - 14

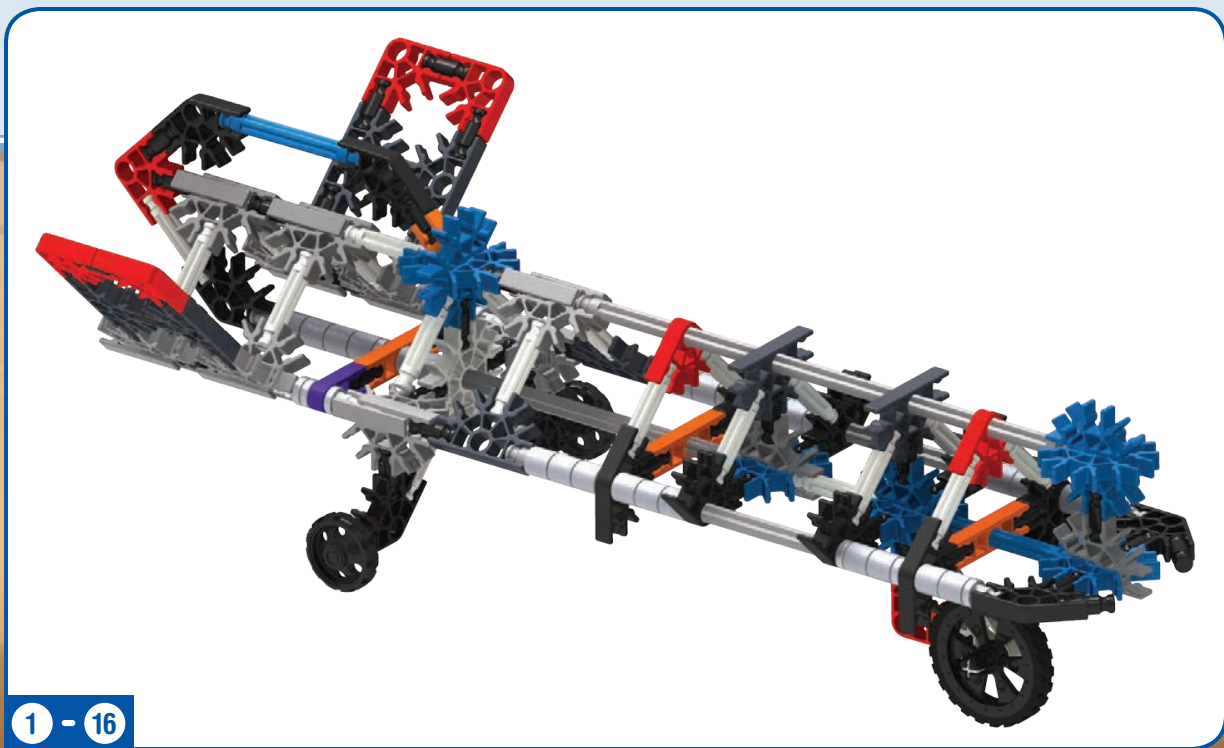
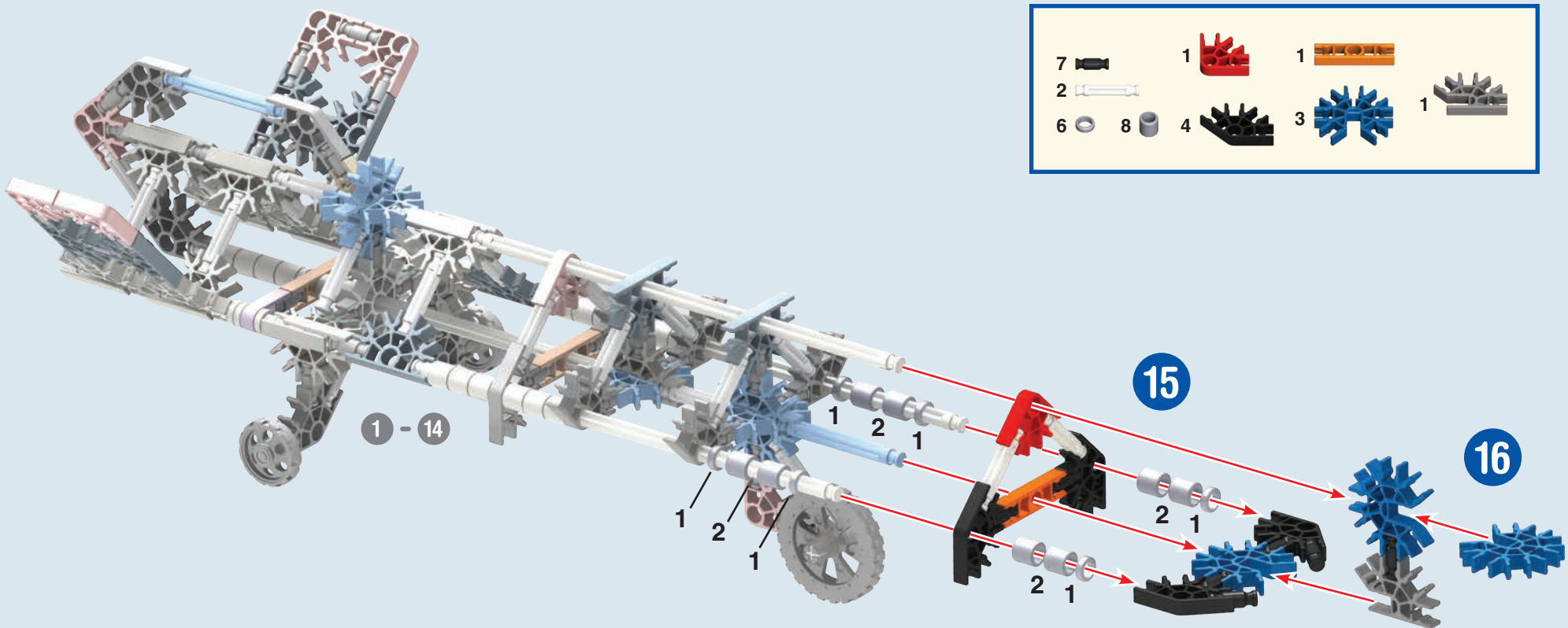

1 - 16

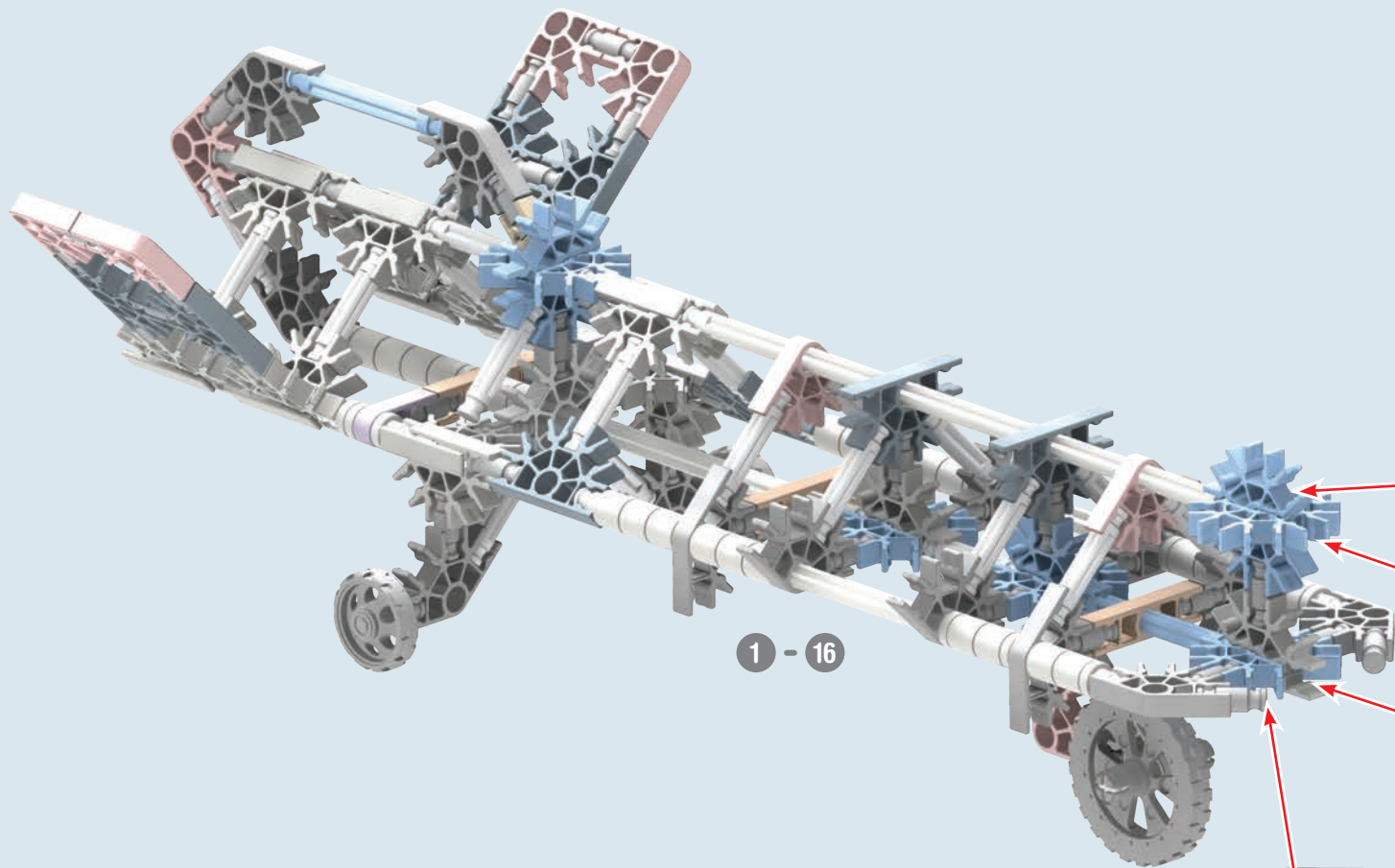

- |   |  |   |  |   |  |
|---|--|---|--|---|--|
| 7 |  | 5 |  | 1 |  |
| 3 |  | 1 |  | 1 |  |
| 1 |  | 1 |  | 1 |  |

1 - 16

17

18

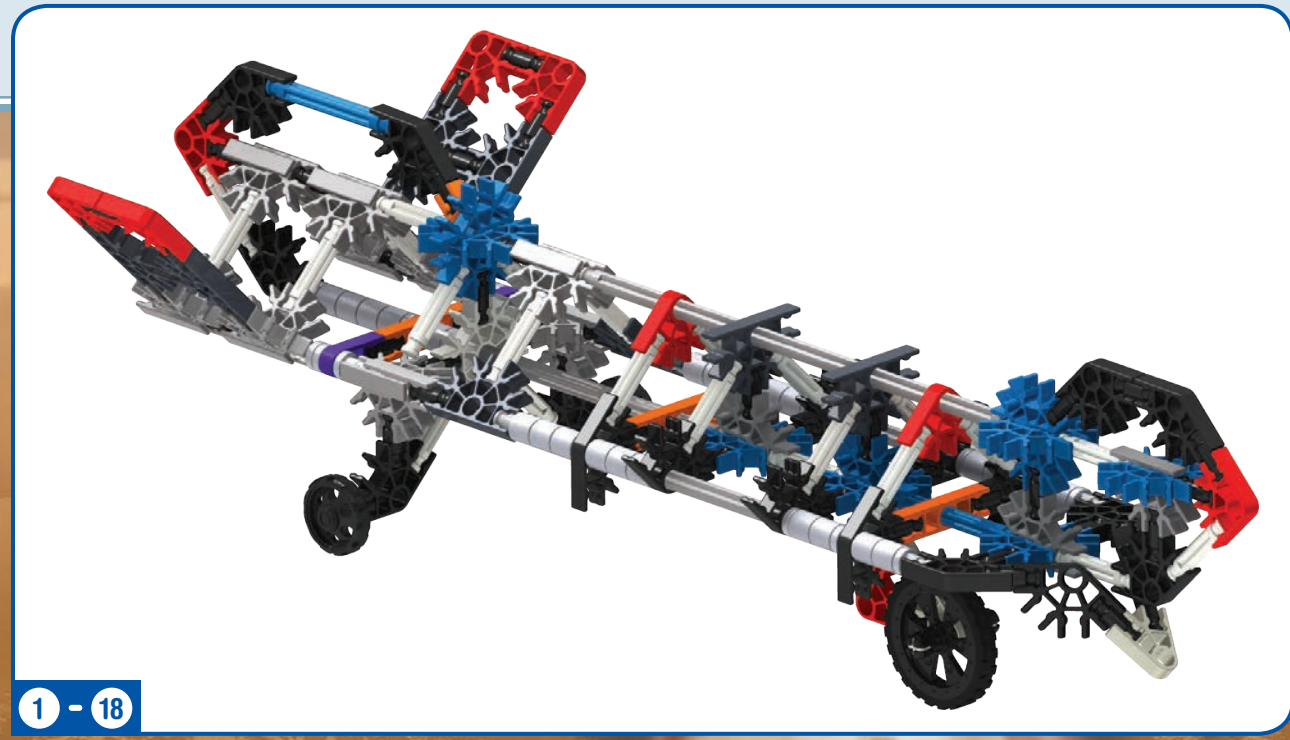
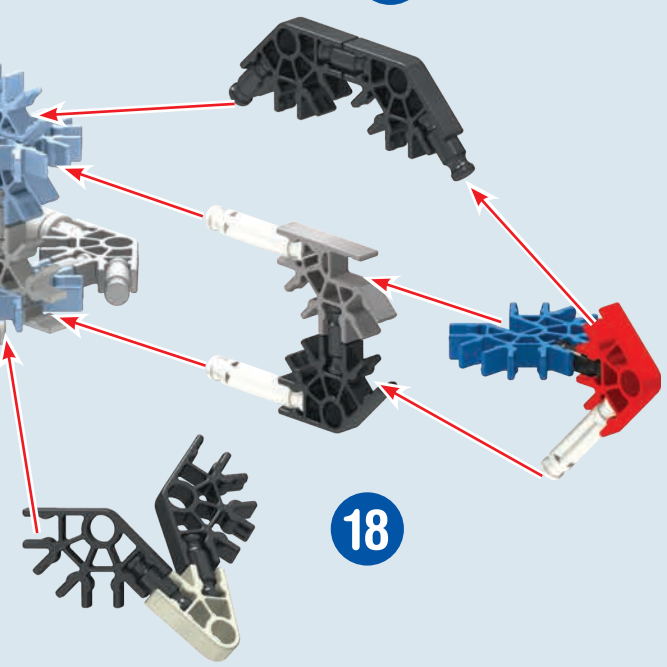

1 - 18

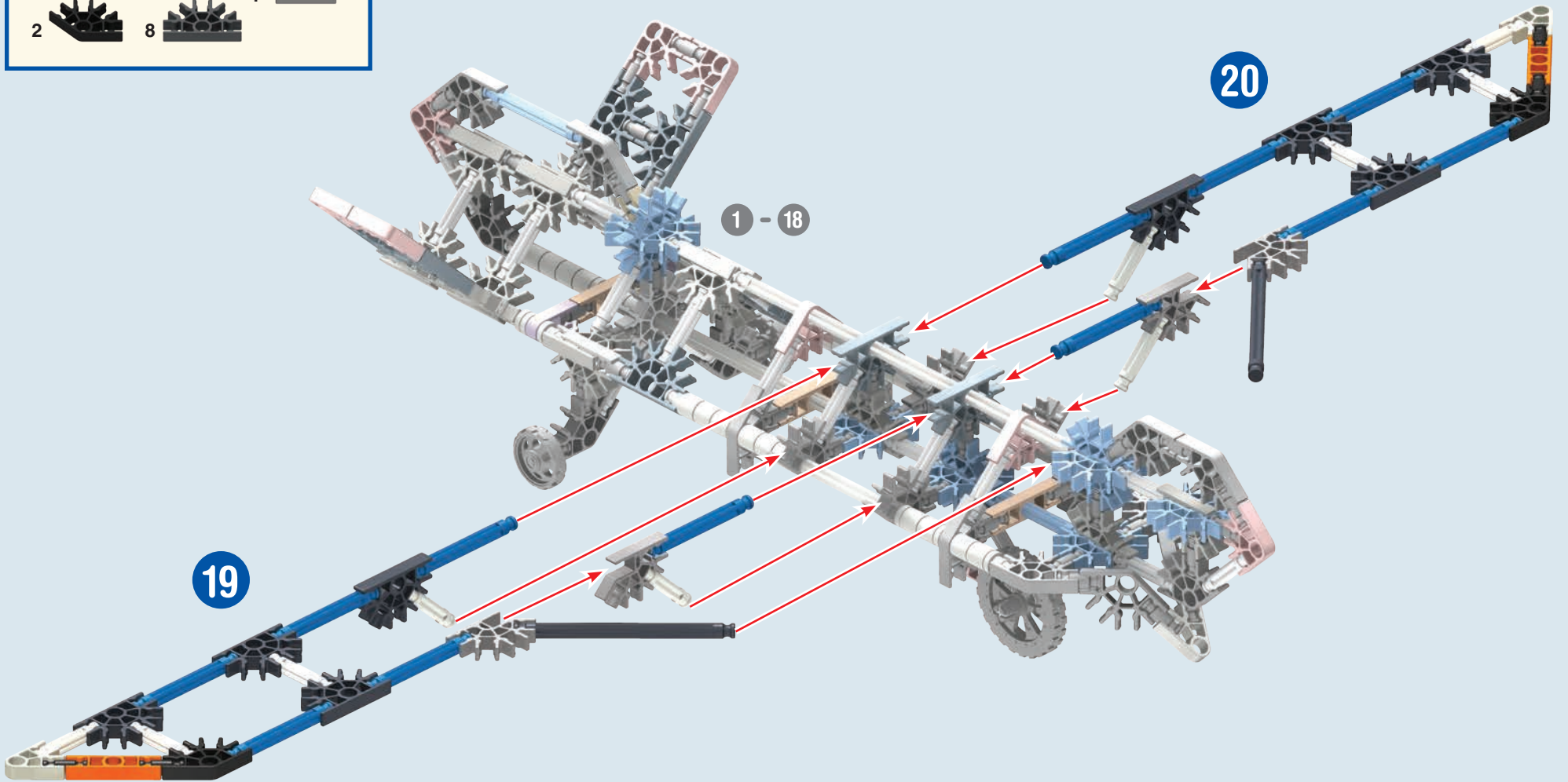
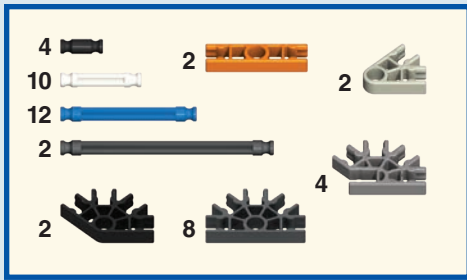

# COMBAT CREW 5-IN-1 BUILDING SET

# ÉQUIPE DE COMBAT 5-EN-1 JEU DE CONSTRUCTION



‡



‡



‡ For instructions of these models go to [www.knex.com/instructions](http://www.knex.com/instructions) and enter code 31480.

Pour les instructions de ces modèles vont à [www.knex.com/instructions](http://www.knex.com/instructions) et entrez dans le code 31480.

(ES) **Español**

(Página 2)

## Guarde esta información importante para futuras referencias

**ADVERTENCIA:** PELIGRO DE ASFIXIA - Piezas pequeñas. No para niños menores de 3 años.

**PRECAUCIÓN:** Mantén el cabello, los dedos, la cara y la ropa alejada de las piezas móviles.

- No apunte K’NEX proyectil a los ojos o la cara.
- Nunca apunte proyectiles K’NEX a otros o animales domésticos.
- Nunca trate de iniciar cualquier proyectil que no sea el K’NEX proyectil.
- No modifique K’NEX proyectil o lanzador.

## Información de la batería

**Cómo insertar y quitar las pilas**

Utilizar un pequeño destornillador principal Phillips para aflojar el tornillo y para quitar la cubierta de batería. Insertar 2 AA (LR6) baterías\*\*\* frescas en el compartimiento de batería con la polaridad correcta (+/-).

Instale las baterías antes de la construcción de modelo.

\*\*\* No se incluyen

**PRECAUCIÓN:** Para evitar fugas en las pilas

- Inserte las pilas de acuerdo con los esquemas de polaridad (+/-).
- No mezcle diferentes tipos de pilas.
- No mezcle pilas alcalinas, estándar (carbón-zinc) o recargables (níquel-cadmio).
- No mezcle pilas viejas con nuevas. Se debe usar solamente pilas del mismo tipo, o las que se recomienden como equivalentes.
- Siempre retire las pilas débiles o gastadas del producto; no forme cortocircuitos en los puntos de intercambio.
- Retire todas las pilas si el juguete no se usará por mucho tiempo.

## Consejos importantes

- Se recomiendan las pilas alcalinas.
- No se recomiendan las pilas recargables.
- Retire las pilas recargables del juguete antes de cargarlas; éstas deben ser cargadas solamente bajo la supervisión de un adulto.
- No se debe recargar las pilas que no son recargables.
- Mantenga los componentes sin polvo; no sumerja ni use en agua.
- No deseché las pilas en el fuego ya que pueden tener fugas, explotar y causar lesiones personales.
- No meta las varillas pequeñas en los orificios del motor ya que dañarían el motor y no se podrían sacar.



El contenedor de basura indica que este producto no puede desecharse con la basura doméstica debido a la presencia de sustancias peligrosas. Para proteger la salud humana y el medio ambiente consultar con la agencia local para el consejo y las facilidades de reciclaje (2012/19/EU, solo Europa).

**Para actualizar las instrucciones visita [KNEX.com](http://KNEX.com)**

(Página 4)

## Básicos de Construcción

### Empieza a construir

Para comenzar tu modelo, busca el 1 y sigue los números. Cada pieza tiene su propia forma y color. Simplemente mira los dibujos, busca las piezas correspondientes en tu juego y después conéctalas. Mientras construyes, trata de colocar tu modelo en la misma dirección que se muestra en las instrucciones. Los colores desteñidos muestran que esta sección ya está construida. Conecta las nuevas secciones en los lugares señalados por las flechas. Las nuevas piezas que agregues estarán en colores vivos.

### Conectores

Hay conectores azules y plateados con ranuras largas especiales. Se enganchan deslizándose como ves en los dibujos. Conecta estas piezas empujándolas hasta que oigas “clíc”.

### Espaciadores

Hay lugares en tu modelo donde tendrás que agregar espaciadores plateados. Cerciórate de usar el color correcto y cuéntalos con cuidado.

### Cadena

Asegúrate de fijar todos los elementos de la cadena en la misma dirección.

(Página 5)

### Lista de Piezas

Antes de empezar con la construcción, asegúrate de comparar las piezas en tu conjunto con la lista de las piezas aquí. Si faltan algunas, llámanos o escríbenos siguiendo las instrucciones en la página trasera. Estamos aquí para ayudarte.

(Página 20, 28)

**¡Construye 2 a la vez!**

(Página 37)

Ya que las instrucciones de los estos modelos van a [www.knex.com/instructions](http://www.knex.com/instructions) y entre en el código **31480**.

(DE) **Deutsch**

(Seite 2)

## Informationen für später aufbewahren

**ACHTUNG:** ERSTICKUNGSGEFAHR - Kleinteile. Nicht geeignet für Kinder unter 3 Jahren.

**VORSICHT:** Haare, Finger, Gesicht und Kleidungsstücke nicht mit beweglichen Teilen in Berührung kommen lassen.

- Mit dem K’NEX Geschoss nicht auf die Augen oder das Gesicht zielen.
- Zielen Sie niemals mit K’NEX Geschossen auf Menschen oder Tiere.
- Versuchen sie niemals einen anderen Gegenstand als das vorgesehene K’NEX Geschoss abzuschliessen.
- K’NEX Geschoss oder Abschussgerät nicht modifizieren.

## Informationen zu den Batterien

**Anweisungen zum Einlegen und Entfernen der Batterien**

Einen kleinen Kreuzkopfschraubenzieher benutzen, um die Schraube zu lösen und die Batterieabdeckung zu entfernen. 2 frische AA (oder LR6) Batterien\*\*\* in den Batterieraum mit der korrekten Polarität einsetzen (+/-).

Batterien vor dem Bau der Modelle einsetzen.

\*\*\* Nicht enthalten

**VORSICHT:** Um ein Auslaufen der Batterien zu vermeiden

- Beim Einlegen der Batterien auf die korrekte Polarität (+/-), wie dargestellt, achten.
- Keine Batterien unterschiedlichen Typs mischen.
- Keine alkaline Batterien, Standard-Batterien (Kohle-Zink) oder wiederaufladbare Batterien (Nickel-Cadmium) mischen.
- Keine alten und neuen Batterien mischen. Nur Batterien des gleichen Typs oder empfohlenen äquivalenten Typs verwenden.
- Leere oder verbrauchte Batterien dürfen nicht wieder aufgeladen werden; darauf achten, dass die Pole der Batterie nicht kurzgeschlossen werden.
- Wenn das Spielzeug längere Zeit nicht verwendet werden soll, alle Batterien entfernen.

## Wichtige Tipps

- Alkaline Batterien werden empfohlen.
- Wiederaufladbare Batterien sind nicht empfohlen.
- Bei Verwendung von wiederaufladbaren Batterien müssen diese aus dem Spielzeug entfernt werden, bevor sie wieder aufgeladen werden; das Wiederaufladen darf nur unter Aufsicht eines Erwachsenen stattfinden.
- Nichtwiederaufladbare Batterien dürfen nicht wieder aufgeladen werden.
- Die Komponenten von Staub freihalten; nicht in Wasser tauchen.
- Zu entsorgende Batterien nicht ins Feuer werfen; sie können auslaufen oder explodieren und Körperverletzungen verursachen.
- In keine der Öffnungen des Motors kleine Stangen einsetzen, sie beschädigen den Motor und können nicht entfernt werden.



Der Abfallbehälter zeigt an, dass dieses Produkt aufgrund von Gefahrstoffen nicht im normalen Hausmüll entsorgt werden kann. Zum Schutz von Gesundheit und Umwelt kontaktieren bitte deine lokale Behörden für Recyclingtipps und –einrichtungen (2012/19/EU, nur Europa).

**Aktualisierte Anleitungen findest du bei [KNEX.com](http://KNEX.com)**

(Seite 4)

## Grundlegende Bauanleitungen für K’NEX

### Los geht’s mit dem Bauen

Um mit dem Bauen deines Modells zu beginnen, suche die Nummer 1 und folge den laufenden Nummern. Jedes Teil hat seine eigene Form und Farbe. Schau dir einfach die Abbildungen an, such die Teile in deinem Bausatz, die so aussehen wie das, was du auf der Abbildung siehst und steck sie ineinander. Versuche, dein Modell beim Zusammenbauen so zu orientieren, dass es in die gleiche Richtung weist, wie es in den Anleitungen beschrieben und gezeigt wird. Blassé Farben weisen darauf hin, dass dieser Streckenabschnitt bereits zusammengebaut ist.

### Verbindungsstücke

Blaue und silberfarbene Verbindungsstücke haben besonders lange Schlitzte. Wie du auf der Abbildung sehen kannst, lassen sie sich ineinander schieben. Achte beim Aneinanderfügen dieser Teile darauf, dass du ein Klickgeräusch hörst. Erst dann sind die Teile fest miteinander verbunden.

### Abstandsstücke

An manchen Stellen in deinem Modell musst du Abstandsstücke einbauen. Achte darauf, die richtige Farbe und Anzahl von Abstandsstücken wie in der Anleitung gezeigt zu verwenden.

### Kette

Achte darauf, alle Kettenglieder in der gleichen Richtung zu verbinden.

(Seite 5)

### Teileliste

Bevor du mit dem Bauen anfängst, solltest du prüfen ob die Teile in deinem Bausatz mit denen auf dieser Teileliste übereinstimmen. Falls etwas fehlt, rufe uns an oder schreibe uns (siehe Rückseite). Wir sind für dich da!

(Seite 20, 28)

**Baut 2 auf einmal!**

(Seite 37)

Für Anweisungen dieser Modelle gehen sie zu [www.knex.com/instructions](http://www.knex.com/instructions) und geben sie Code **31480** ein.

(IT) **Italiano**

(Pagina 2)

## Conservare queste importanti informazioni per riferimento futuro

**AVVISO:** PERICOLO DI SOFFOCARE - Pezzi piccoli. Non adatto per bambini sotto 3 anni.

**ATTENZIONE:** Tenere i capelli, le dita, il viso e i vestiti lontano da tutte le parti in movimento.

- Non puntare il proiettile di K’NEX a l’ occhi o alla faccia.
- Non mai puntare proiettili di KNEX a persone o animali domestici.
- Non mai tentare di lanciare qualsiasi altro proiettile oltre a il proiettile di K’NEX.
- Non modificare mai la proiettile di K’NEX o lancio.

## Informazioni sulle batterie

**Come inserire e rimuovere le batterie**

Utilizzare un piccolo cacciavite phillips per allentare la vite e per rimuovere la copertura di batteria. Inserire 2 AA (o LR6) batterie\*\*\* fresche nello scompartimento di batteria con la polarità corretta (+/-).

Installare le batterie prima di modelli di edifici.

\*\*\* Non include

**ATTENZIONE:** Come evitare perdite delle batterie

- Inserire le batterie con la polarità corretta (+/-) come illustrato.
- Non mischiare tipi diversi di batterie.
- Non mischiare alcaline, standard (carbonio-zinco) e ricaricabili (nichel-cadmio).
- Non mischiare insieme batterie nuove e vecchie. Usare sempre batterie raccomandate dello stesso tipo o di tipo equivalente.
- Rimuovere sempre batterie quasi scariche o completamente scariche dal prodotto; non causare corto circuito ai terminali di alimentazione.
- Non gettare le batterie nel fuoco, poiché potrebbero perdere o esplodere e causare lesioni.

## Consigli importanti

- Si raccomanda l’uso di batterie alcaline.
- Non si raccomanda l’uso di batterie ricaricabili.
- Rimuovere le batterie ricaricabili dal giocattolo prima della carica: devono essere caricate solo sotto la supervisione di un adulto.
- Le batterie non ricaricabili non devono essere ricaricate.
- Mantenere i componenti privi di polvere; non immergere o usare in acqua.
- Rimuovere tutte le batterie se il giocattolo non verrà usato per un lungo periodo di tempo.
- Non inserire aste più corte nei fori del motore, in quanto danneggerebbero il motore e non possono essere rimosse.



Il bidone della spazzatura indica che questo prodotto non si può buttare via con i rifiuti domestici a causa della presenza di sostanze pericolose. Per proteggere la salute umana e l’ambiente, devi controllare con la tua autorità locale per consigli e impianti di riciclaggio (2012/19/EU, solo in Europa).

**Gli Aggiornamenti alle Istruzioni si trovano online all’indirizzo [KNEX.com](http://KNEX.com)**

(Pagina 4)

## Istruzioni di base per costruire con K’NEX

### Comincia a costruire

Per iniziare il modello, cerca il numero 1 e segui i numeri. Ogni pezzo ha una sua forma e un suo colore. Guarda la figura, trova i pezzi corrispondenti nel set e mettili insieme. Cerca di tenere il modello nella stessa direzione della figura e in tal modo sarà più semplice attaccare i pezzi nei posti giusti. I colori spenti ti dicono che questa sezione è già stata costruita. Dovrai collegare la nuova sezione al punto indicato dalla punta della freccia.

### Connettori

È molto importante posizionare i connettori blu e argento in una specifica direzione. Presta molta attenzione alle istruzioni e posiziona i connettori orizzontalmente o verticalmente proprio come illustrato. Spingi con forza fino ad udire un clic.

### Spaziatori

Ci sono punti nel tuo modello a cui dovrai aggiungere spaziatori argento. Accertati si contarli attentamente.

### Catena

Accertati di attaccare tutti i collegamenti della catena nella stessa direzione.

(Pagina 5)

### Elenco delle parti

Prima di cominciare a costruire, accertati di confrontare le parti che sono nel tuo set con l’elenco delle parti qui. Se ne manca una chiamaci o scrivicci usando le informazioni che sono nella retrocopertina. Noi siamo qui per aiutarti!

(Pagina 20, 28)

**Costruisci 2 alla volta!**

(Pagina 37)

Per istruzioni di questi modelli vai a [www.knex.com/instructions](http://www.knex.com/instructions) e’ inserire il codice **31480**.

(PT) **Português**

(Página 2)

## Manter esta informação importante para referência futura

**AVISO:** PERIGO DE SUFOCAÇÃO - Peças pequenas. Não se destina a crianças com menos de 3 anos de idade.

**CUIDADO:** Mantém o cabelo, os dedos, a cara e a roupa afastados de todas as peças móveis.

- Não visam K'NEX projétil nos olhos ou na face.
- Nunca objetivo K'NEX ogivas para os outros ou de animais de estimação.
- Nunca tente lançar qualquer projétil que não seja o projétil K'NEX pretendido.
- Não modificar K'NEX projétil ou launcher.

## Informações sobre as pilhas

### Como introduzir e remover baterias

Usar uma chave de fenda principal pequena de Phillips para afrouxar o parafuso e para remover a tampa de bateria. Introduzir 2 AA (ou LR6) baterias\*\*\* frescas no compartimento de bateria com a polaridade correta (+/-).

Instale baterias antes modelos de construção.

\*\*\* Não estão incluídas

### CUIDADO: Para evitar fugas das pilhas

- Introduza as pilhas com a polaridade correcta (+/-), conforme se mostra.
- Não misture tipos diferentes de pilhas.
- Não misture pilhas alcalinas, padrão (carbono-zinco) ou pilhas recarregáveis (níquel-cádmio).
- Não combine pilhas usadas com pilhas novas. Apenas pilhas do mesmo tipo ou equivalentes ao tipo recomendado.
- Retire sempre as pilhas fracas ou gastas do produto; não provoque um curto-circuito nos terminais de alimentação.
- Retire todas as pilhas do brinquedo se não tencionar usá-lo durante um longo período de tempo.

### Conselhos importantes

- Recomenda-se o uso de pilhas alcalinas.
- Não se recomenda o uso de pilhas recarregáveis.
- Retire as pilhas recarregáveis do brinquedo antes de as carregar; estas pilhas devem ser recarregadas apenas sob vigilância de adultos.
- As pilhas não recarregáveis não devem ser carregadas.
- Mantenha os componentes livres de poeiras; não mergulhe em água nem use água.
- Não elimine as pilhas queimando-as; estas podem apresentar fugas ou explodir causando lesões.
- Não coloque varetas de tamanho inferior em nenhuma abertura do motor; as varetas causarão danos no motor e não podem ser removidas.



O caixote do lixo indica que este produto não pode ser descartado junto com o lixo doméstico devido à presença de substâncias perigosas.

Para proteger a saúde humana e o meio ambiente verifique a sua autoridade local para reciclagem conselho e instalações (2012/19/EU, somente na Europa).

**Entre em K'NEX.com para ver actualizações e instruções**

(Página 4)

## Pontos básicos para a construção K'NEX Inicia a construção

Para começar o teu modelo, procura o 1 e segue os números. Cada peça tem a sua própria forma definida e cor. Basta simplesmente olhares para a ilustração, procurar as peças do teu jogo correspondentes às que estás a ver e, em seguida, conectar

umas nas outras. Enquanto estás a montar as peças, tenta manter o teu modelo na mesma direcção, conforme mostrado na ilustração, para assim ligares as peças correctamente. As cores desbotadas indicam que esta secção já está montada. Passarás então a fazer a conexão da nova secção no local indicado pelas setas.

### Conectores

É muito importante que posições os conectores azuis e cor de prateados numa direcção específica. Presta muita atenção às instruções e coloca estes conectores horizontal ou verticalmente, exactamente conforme se mostra nas ilustrações. Junta as partes simultaneamente e com firmeza até ouvires um "estalido".

### Espaçadores

Existirão certos pontos no teu modelo que necessitam a colocação de espaçadores prateados. Assegura-te que os contos cuidadosamente.

### Corrente

Assegura-te que prendes todos os elos da corrente seguindo a mesma direcção.

(Página 5)

### Lista de peças

Antes de iniciares a construção, certifica-te de que comparas as peças do teu conjunto com a lista das peças aqui. Se faltar alguma peça telefona ou escreve-nos usando as informações indicadas na contracapa. Estamos aqui para te ajudar!

(Página 20, 28)

**Constrói 2 de uma vez!**

(Página 37)

Para obter instruções destes modelos vá em [www.knex.com/instructions](http://www.knex.com/instructions) e digite o código 31480.

(NL) **Nederlands**

(Bladzijde 2)

## Bewaar deze belangrijke informatie, zodat u deze in de toekomst opnieuw kunt raadplegen

**WAARSCHUWING:** INSLIKKINGSGEVAAR - Kleine onderdelen. Niet geschikt voor kinderen jonger dan 3 jaar.

**OPGEPAST:** Houd handen, haar, gezicht en kleding uit de buurt van bewegende onderdelen.

- Niet gericht K'NEX projectiel op de ogen of het gezicht.
- Doel Nooit K'NEX projectielen op anderen of huisdieren.
- Nooit proberen om een andere dan de bedoelde K'NEX projectiel projectiel te lanceren.
- Verander niet K'NEX projectiel of launcher.

## Informatie over Batterijen

### Batterijen plaatsen en verwijderen

Gebruik een kleine kruiskopschroevendraaier om de schroef van het klepje los te draaien. Plaats 2 nieuwe AA-batterijen\*\*\* (LR6) in het batterijvak en let daarbij op de polariteit (+/-), zoals hier wordt getoond. Plaats de batterijen voordat je een model bouwt.

\*\*\* Niet inbegrepen

### WAARSCHUWING: Voorkom lekkende batterijen

- Let op de polariteit bij het plaatsen van batterijen (+/-), zoals wordt getoond.
- Gebruik geen verschillende typen batterijen samen.
- Gebruik geen alkaline, gewone (koolstof-zink) of oplaadbare (nikkel-cadmium) batterijen samen.

- Gebruik geen nieuwe en gebruikte batterijen samen. Gebruik uitsluitend batterijen van het aanbevolen type of van een gelijkwaardig type.
- Verwijder lege batterijen uit het speelgoed. Vermijd kortsluiting.
- Verwijder de batterijen uit het speelgoed als het langere tijd niet wordt gebruikt.

### Belangrijke tips

- Alkalinebatterijen worden aanbevolen.
- Oplaadbare batterijen worden niet aanbevolen.
- Verwijder oplaadbare batterijen voordat u ze oplaadt. Het opladen mag uitsluitend gebeuren onder toezicht van een volwassene.
- Niet-oplaadbare batterijen mogen niet worden opgeladen.
- Houd de onderdelen stofvrij. Niet in water dompelen of gebruiken.
- Gooi batterijen niet in het vuur. Ze kunnen lekken of exploderen en schade veroorzaken.
- Steek geen kort staafjes in de openingen van de motor. Deze kunnen de motor beschadigen en klem komen te zitten.



Het pictogram van een verwijdbare vuilnisbak geeft weer dat dit product niet samen met het gewone huis-, tuin- en keukenafval mag worden weggegooid, omdat het gevaarlijke substanties bevat.

Bescherm gezondheid en milieu en vraag advies aan de plaatselijke afvalverwerkingsdienst over hoe en waar u producten kunt recyclen (2012/19/EU, alleen Europa).

**Ga naar K'NEX.com voor Bijwerkingen voor aanwijzingen**

(Bladzijde 4)

## Basisstappen voor K'NEX bouwen

### Begin te bouwen

Om met je model te beginnen, vind eerst het nummer 1 en volg de nummers. Elk stuk heeft zijn eigen vorm en kleur. Kijk gewoonweg naar de afbeeldingen, vind de overeenstemmende stukken terug in je geheel en maak ze aan mekaar vast. Tracht je model in dezelfde richting te plaatsen als de aanwijzingen terwijl je bouwt en monteert. De vervaagde kleuren duiden aan dat dit deel reeds is opgebouwd. Gelieve het nieuwe deel vast te koppelen op de plaats aangeduid door de pijlen.

### Verbindingsstukken

Je kunt deze speciale verbindingsstukken in elkaar steken. Duw ze stevig tegen elkaar aan tot je een 'klik' hoort. Let goed op de instructies en plaats ze horizontaal en verticaal, precies zoals wordt getoond.

### Afstandhouders

Op bepaalde plekken van je model moet je afstandhouders gebruiken. Zorg dat je het juiste aantal afstandhouders gebruikt, zoals wordt getoond in de instructies.

### Keten

Maak zeker dat alle ketenschakels vastgemaakt worden in dezelfde richting.

(Bladzijde 5)

### Lijst met onderdelen

Controleer aan de hand van deze lijst of je set alle onderdelen bevat voordat je begint te bouwen. Als er een onderdeel ontbreekt, bel of schrijf ons dan. Je vindt onze gegevens op de achterkant. We helpen je graag!

(Bladzijde 20, 28)

**Bouwt 2 tegelijk!**

(Bladzijde 37)

Voor instructies van deze modellen naar [www.knex.com/instructions](http://www.knex.com/instructions) en vul de code 31480.

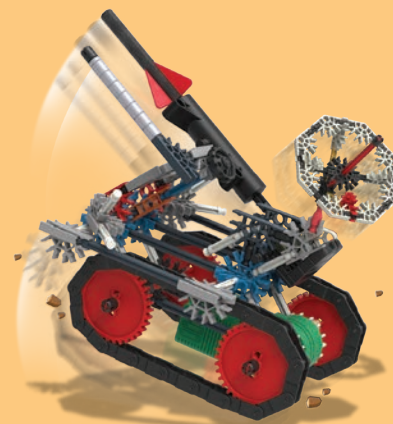
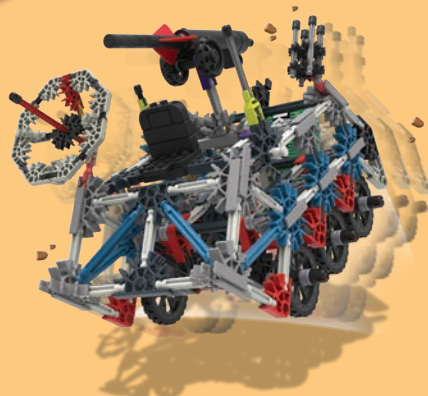
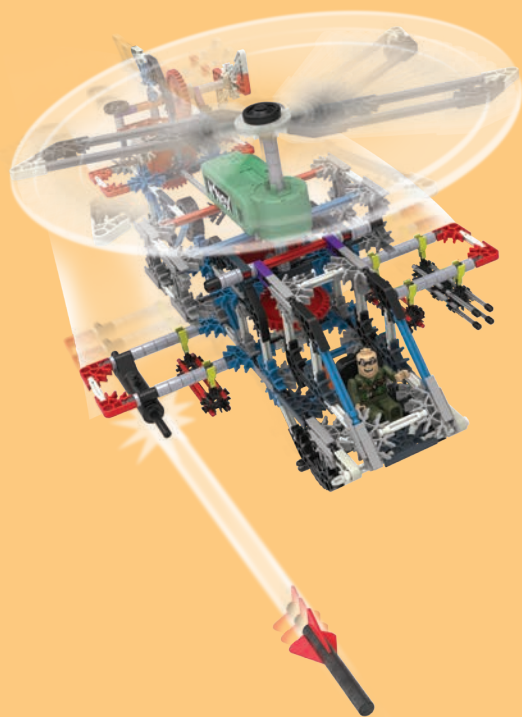

### BEASTS ALIVE

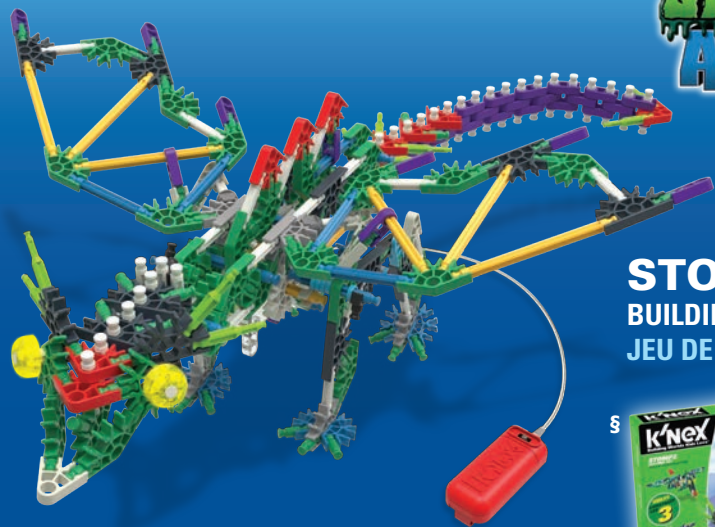

### STOMPZ BUILDING SET JEU DE CONSTRUCTION



Beasts Alive is a registered trademark of K'NEX Limited Partnership Group.  
Beasts Alive est une marque déposée de K'NEX Limited Partnership Group.  
Beasts Alive es una marca registrada de K'NEX Limited Partnership Group.

### BEASTS ALIVE



### BRONTO BUILDING SET JEU DE CONSTRUCTION



Beasts Alive is a registered trademark of K'NEX Limited Partnership Group.  
Beasts Alive est une marque déposée de K'NEX Limited Partnership Group.  
Beasts Alive es una marca registrada de K'NEX Limited Partnership Group.



### 70 MODEL BUILDING SET 70 MODÈLES JEU DE CONSTRUCTION

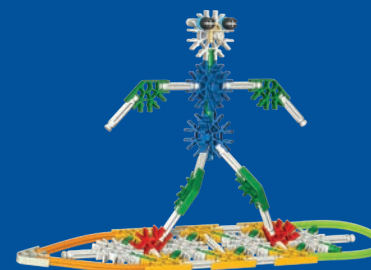

§ Sold separately. Some products may not be available in all markets.

Vendus séparément. Certains produits ne sont pas disponibles pour tous les marchés.  
Se venden por separado. Algunos productos no pueden estar disponibles en todos mercados.  
Separat verkauft. Einige Produkte können möglicherweise nicht in allen Märkten vorhanden sein.  
Venduto esclusivamente. Alcuni prodotti non possono essere disponibili in tutti i mercati.  
Vendido separada. Alguns produtos não podem estar disponíveis em todos os mercados.  
Afzonderlijk verkocht. Sommige producten kunnen niet in alle markten beschikbaar zijn.